



# Sustainable Columbus Community Choice Aggregation

Powering Columbus with 100% clean energy

September 10, 2020

# Community Choice Aggregation with renewables contributes to our goals for climate and community prosperity



# Today's purpose is to share our approach to delivering on this goal

Specifically, we hope to:

- Discuss Community Choice Aggregation Basics
- Share our Sustainable Columbus Community Choice Aggregation goals
- Ask for your feedback on how we should talk about Community Choice Aggregation in the community
- Discuss what to expect in future meetings

**Your input will allow us to further develop our policy approach**

# How we would like to work together

## The role we hope you will play

1. Provide input on sustainability-focused community priorities
2. Share information on aggregation with your organization and community members

## Suggested group norms

1. Use video whenever possible
2. Minimize distractions
3. Practice the democracy of time
4. *Anything else?*

# A few Zoom reminders for today

## Advisory Group Members:

- **Please mute** when not speaking
- Please *also* use the chat function to react, ask questions, and comment!
- Please **rename yourself with name and org** by right clicking on the 3 dots on your image
- To **annotate**, you'll need to find the annotation tools →

### To annotate on a shared screen

1. At the top of your screen, click **View Options**.
2. Click **Annotate**.

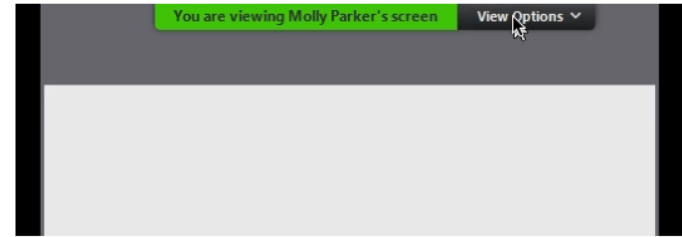

3. This will open the annotation tools.
4. Close the annotation tools at any time by clicking the **X** in the annotation tool bar.

**Please note:** this meeting is being recorded and will be shared publicly

**Members of the public observing:** Welcome! Please ask questions at any time, and we will address these at two points during the agenda.

# Your hosts and facilitators for today

- **Erin Beck**, Policy Advisor, Office of the Mayor
- **Alana Shockey**, Assistant Director for Sustainability, Department of Public Utilities
- **Samantha Schneider**, Energy Manager, City of Columbus
- **Jenna Tipaldi**, Climate Advisor, Natural Resources Defense Council
- **Sonya Suter**, Delivery Leader, Delivery Associates
- **Scott Belcastro**, Principal, Trebel

# Trebel will be helping to set up and run our aggregation program

- Trebel, LLC is a national energy consulting company serving commercial, governmental, small business and residential clients primarily throughout the deregulated energy markets.
- Trebel is a leader in Community Aggregation for Townships / Villages / Cities / Counties
- Over 160 combined electric and natural gas programs under management
- Operate in all Utilities throughout Ohio



# Icebreaker Time



- Name
- Organization
- Favorite Pizza Topping



# Agenda

- *Introductions & our objectives today*
- Energy system & community choice refresher
- Sustainable Columbus Community Choice Aggregation Goals
- Closing and next steps



**SUSTAINABLE  
COLUMBUS**  
ANDREW J. GINTHER, MAYOR

# Electric Energy System & Community Choice Refresher

How does this all work?

# Our electricity system is composed of generation, transmission, and distribution

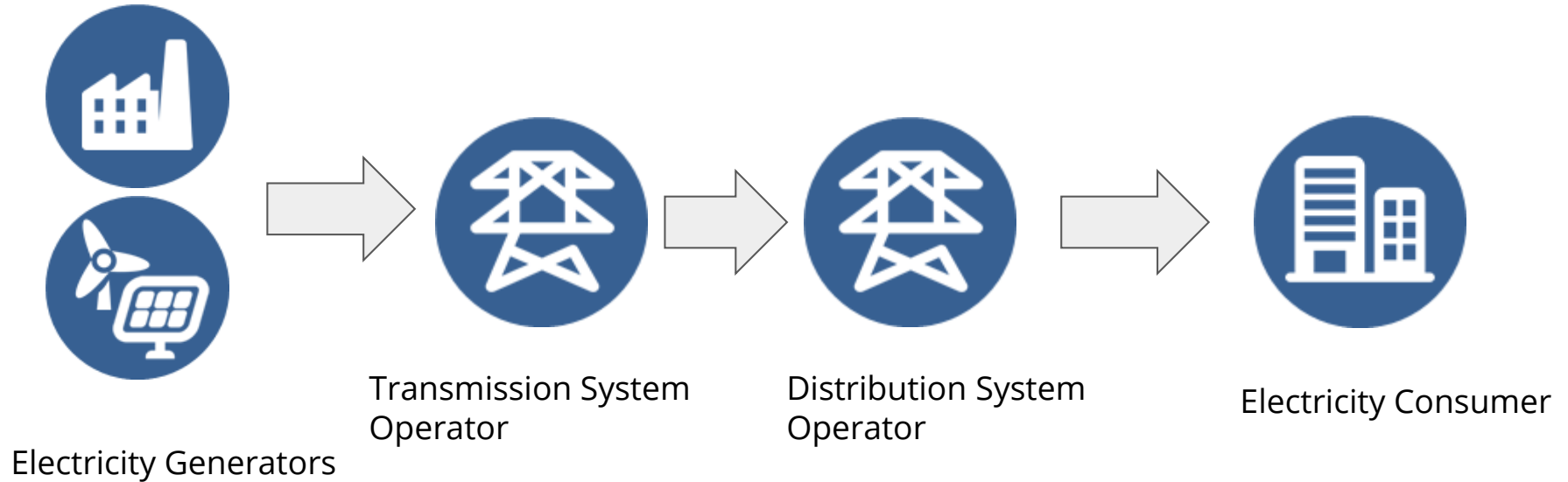

# Most customers use AEP Ohio's Standard Service Offer (SSO) that covers generation, transmission, and distribution

## AEP Ohio Standard Service Offer

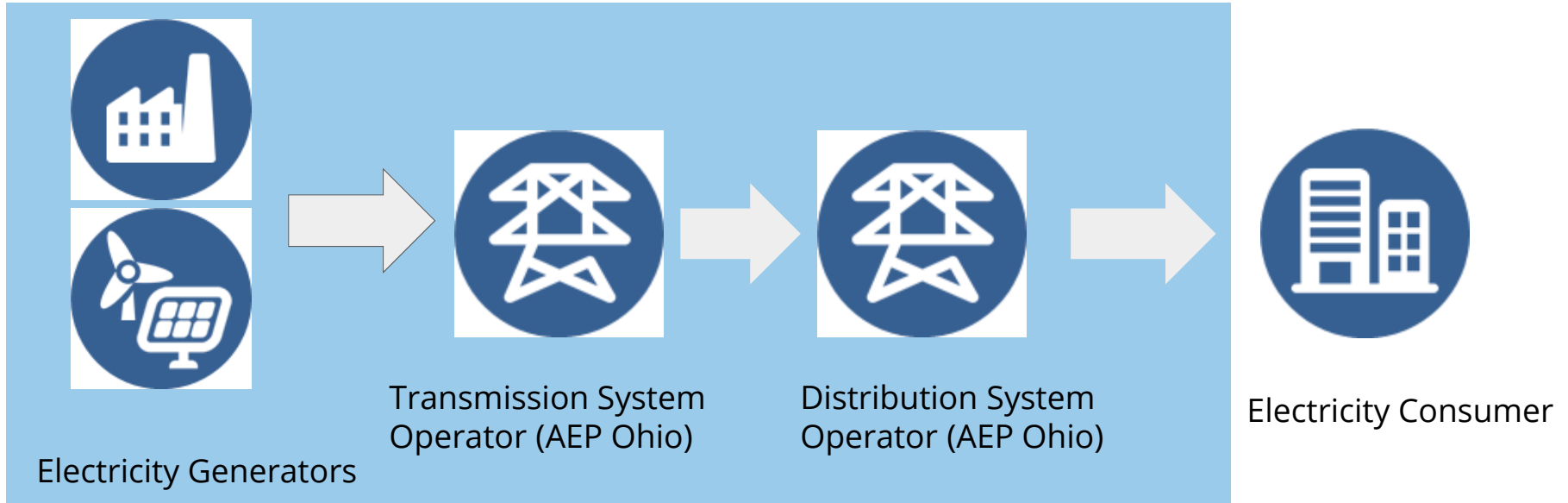

# AEP Ohio handles your transmission and distribution, but does not generate your electricity

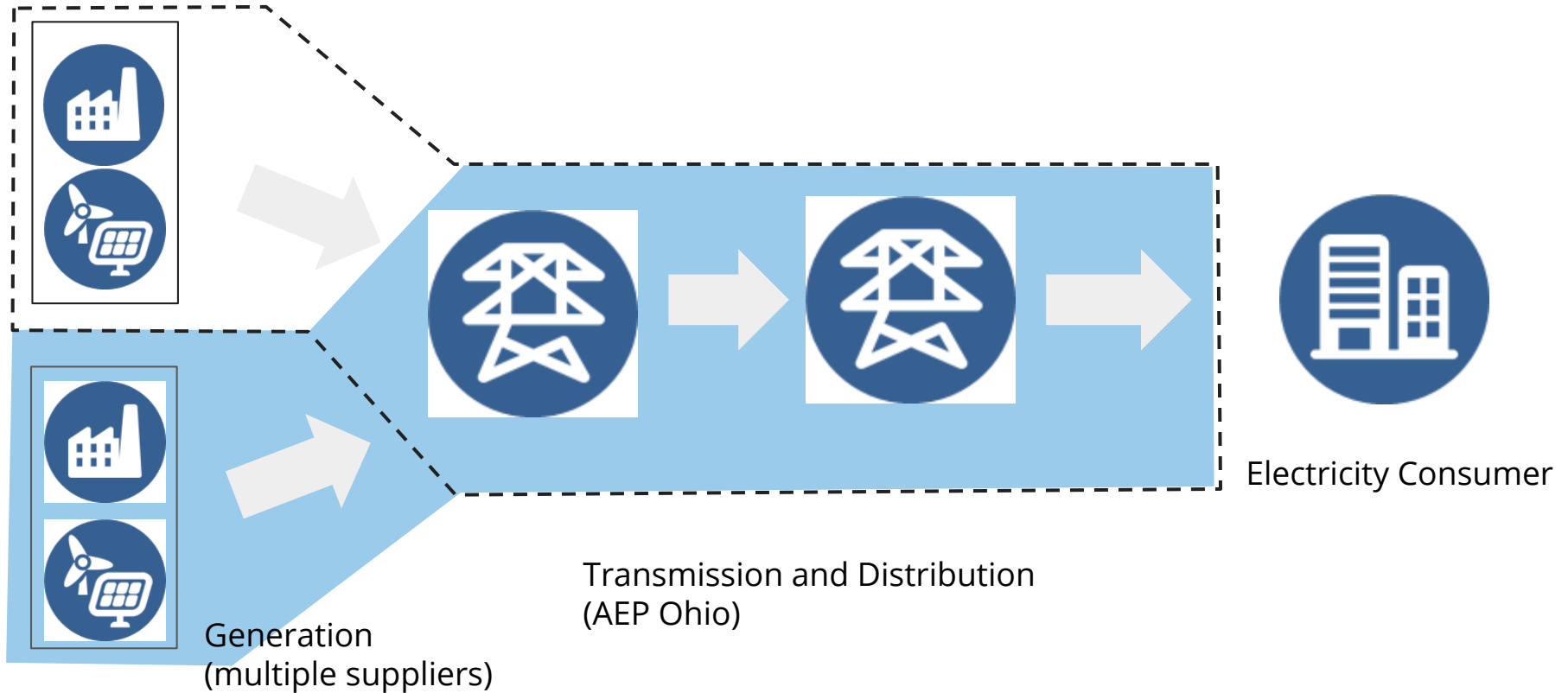

# Ohio is also one of seven states with legislation permitting community choice aggregation

States with Approved CCA Legislation



Source: EPA

# Meaning we are also allowed to aggregate our supply

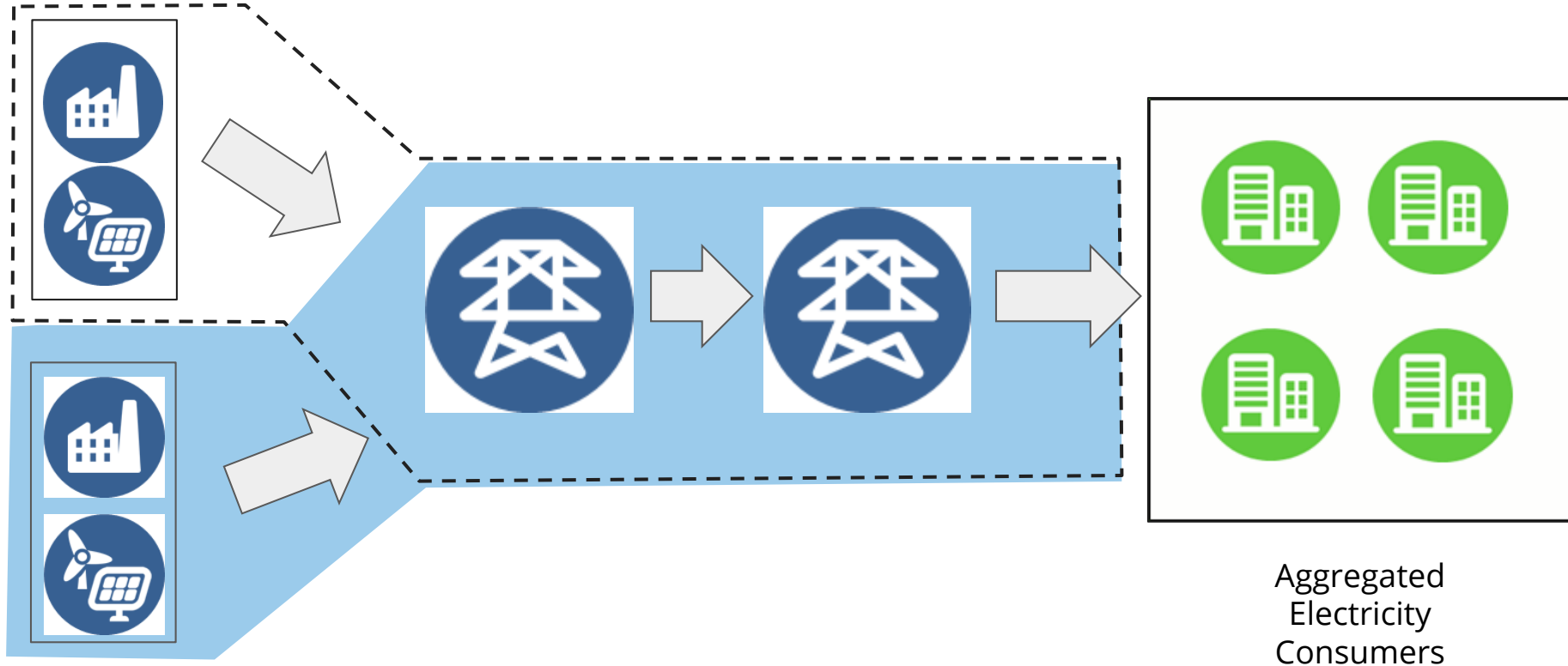

# What is community choice aggregation?

- Community choice aggregation is an easy and effective way for **local officials to contract for competitively priced electricity** based on group buying power for its residents.
- **Under community choice aggregation, the City of Columbus will contract to provide residents and small businesses competitively priced, clean electricity** from a retail generation supplier certified by the Public Utilities Commission of Ohio.
- **Any Columbus resident or small business served by AEP Ohio will be eligible to participate** in the City's community choice aggregation program.



# How do residents join a community choice aggregation program?

- First, the **community choice aggregation issue will be on the ballot on November 3rd**, and must be passed by a majority of the voters.
- Once passed, **all eligible residents and small businesses in the community will be enrolled** and will begin receiving the renewable and clean energy generation pricing under the program.
- **Residents do not need to do anything to join the program.**

**We also have a website with answers to frequently asked questions:**

<https://www.cleanenergycolumbus.org/>

# Opting out and other alternatives

## What are my energy supply choices if I decide to opt-out?

You can stay with your current utility who will place you with a supplier of their choice, and will continue to supply your electricity as it always has, or you can shop for an alternative generation supplier

## What if I've already selected an alternative generation supplier?

If you have already chosen an alternative supplier and community choice aggregation is approved by the voters, you will stay with your chosen supplier and you will not be sent an opt- out letter. Again, since you are currently in a contract, we simply remove you from the program at the beginning. You will have the option to join the City's community choice aggregation program when you decide it is best. The choice is always yours.

# You will still receive one bill for transmission, distribution, and generation



## Line Item Charges:

Previous Charges		
Total Amount Due At Last Billing	\$	19.91
Payment 07/28/20 - Thank You		-19.91
<b>Previous Balance Due</b>	<b>\$</b>	<b>.00*</b>
Current AEP Ohio Charges		
<b>Tariff 820 - Residential Service 08/04/20</b> Service Delivery Identifier: 00040621044820373		
Transmission Service	\$	3.88
Distribution Service		11.47
Customer Charge		8.40
<b>Current Electric Charges</b>	<b>\$</b>	<b>23.75*</b>

Generation (electricity)  
charge through supplier



Current AEP Energy Inc Charges (866-258-3782)		
Service Delivery Identifier: 00040621044820373 08/04/20		
Generation 156 kWh @ \$0.043	\$	6.71
<b>Current Supplier Balance Due</b>	<b>\$</b>	<b>6.71*</b>

<b>Total Balance Due</b>	<b>\$</b>	<b>30.46</b>
*Charges make up the "Total Balance Due" The Amount Will Be Deducted From Your Bank Account On August 21, 2020.		

Transmission, distribution,  
customer charges by  
distribution utility

# What are the Key Milestones?

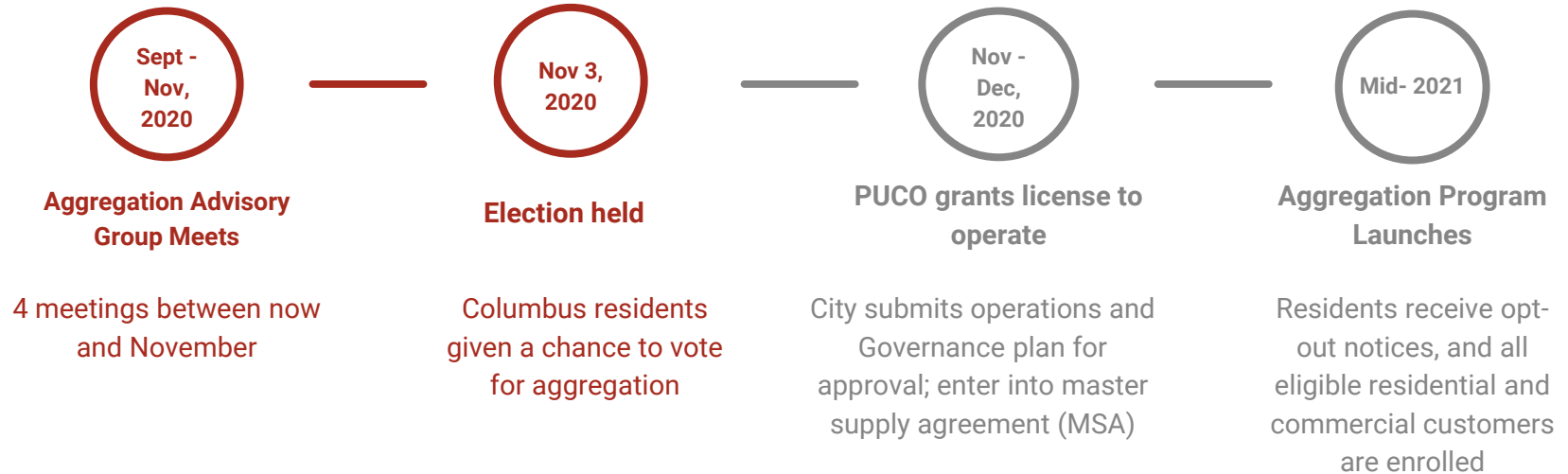

# Temperature Check

How comfortable do you feel with what has been shared so far?

- *1 finger: What language are you speaking?*
- *5 fingers: I should be explaining this to YOU*

What questions do you have?



**SUSTAINABLE  
COLUMBUS**

ANDREW J. GINTHER, MAYOR

# Sustainable Columbus Community Choice Aggregation Goals

What are we trying to achieve?

# Aggregation will have multiple benefits for Columbus



RENEWABLE ENERGY

## 100% CLEAN ENERGY

Columbus' goal is 100% clean, renewable energy by 2022 and to be carbon neutral by 2050. Clean energy can include sources such as wind and solar.

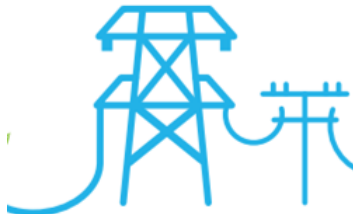

SAME RELIABLE SERVICE

## CLEAN ENERGY JOBS

Community choice aggregation creates demand for local renewable energy sources and good paying jobs that support workforce development in the clean energy industry.



YOUR COMMUNITY CHOICE

## COMMUNITY CHOICE

The City bulk-purchases energy on behalf of residents and small businesses, providing competitive pricing and local control of the energy source. Residents receive the same service & bill from AEP. Participation is voluntary and residents can opt-out at any time.

# It starts with a Vote...

**On July 20th, the City of Columbus passed legislation to place clean energy electric aggregation on the November 3rd ballot. The language will appear as:**

Shall the City of Columbus have the authority to aggregate the retail electric loads located within the incorporated areas of the City, to support local clean energy generation, energy savings, and Columbus's sustainable economy and for that purpose, enter into services agreements to facilitate for those loads the sale and purchase of electricity, such aggregation to occur automatically except where any person elects to opt-out, in accordance with Section 4928.20 of the Ohio Revised Code and Ordinance No. 1642-2020 adopted by the Council?



# Columbus will use our energy supply contract for 100% renewable electricity

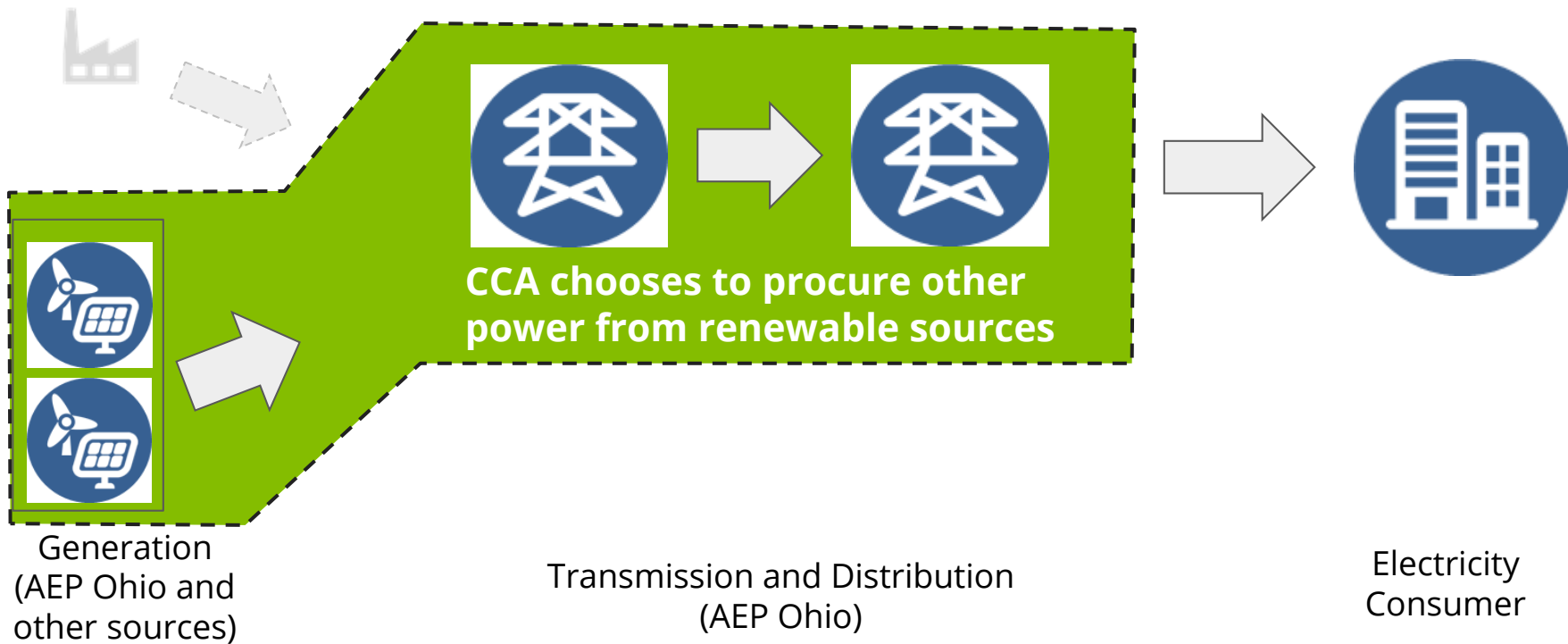

# Aggregation will have multiple benefits for Columbus



RENEWABLE ENERGY

## 100% CLEAN ENERGY

Columbus' goal is 100% clean, renewable energy by 2022 and to be carbon neutral by 2050. Clean energy can include sources such as wind and solar.



SAME RELIABLE SERVICE

## CLEAN ENERGY JOBS

Community choice aggregation creates demand for local renewable energy sources and good paying jobs that support workforce development in the clean energy industry.



YOUR COMMUNITY CHOICE

## COMMUNITY CHOICE

The City bulk-purchases energy on behalf of residents and small businesses, providing competitive pricing and local control of the energy source. Residents receive the same service & bill from AEP. Participation is voluntary and residents can opt-out at any time.

Which of these resonates most with you?

# Discussion

How should we talk about aggregation in the community?

- What resonates most with you about aggregation?
- What is confusing or what concerns you?
- How can we best talk about this with our neighbors?

# Our next meetings together

Meeting #1: Introductions and Aggregation 101 - TODAY!

Meeting #2: Aggregation in Action - Overview of Governance and Operation - September 24

Meeting #3: Columbus' Renewable Energy Future - October 8

Meeting #4: Community Priorities and Sustainability Goals - October 22

Meeting #5: Wrap Up/Next Steps