

VICTORIAN  
VILLAGE  
HANDBOOK

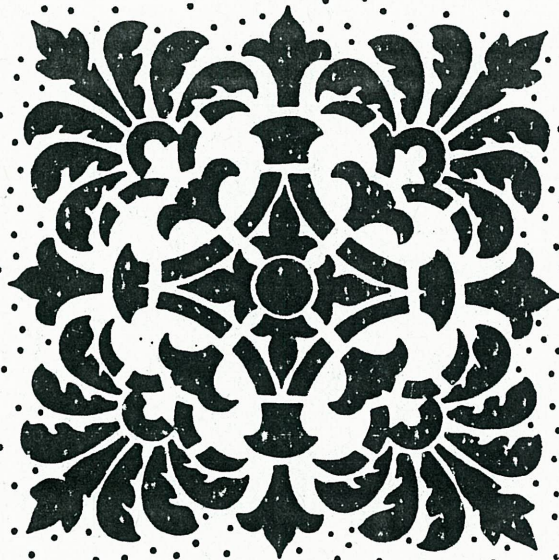

Including Guidelines for Rehabilitation and New Construction





*Staff*

Columbus Department of Human Services  
Division of Neighborhood Services

Martha Trout, Neighborhood Services Coordinator  
Addie Morrison, Neighborhood Specialist  
Kevin Might, Intern

The publication of the Victorian Village Handbook was made possible in part by a grant from the United States Department of the Interior's National Park Service, administered by the Ohio Historic Preservation Office of the Ohio Historical Society. The mention of trade names or commercial products does not constitute or imply their endorsement or recommendation by the Department of the Interior or the Ohio Historical Society.

The U.S. Department of the Interior prohibits discrimination on the basis of race, color, national origin or handicap. If you believe you have been discriminated against, please write to the Office of Equal Opportunity, U.S. Department of the Interior, Washington, D.C. 20240.



# Victorian Village Commission

50 W Gay Street Columbus, Ohio 43215 614-222-7561

Autumn, 1988

Dear Neighbors:

This Handbook is for the property owners and residents of Victorian Village. After providing background on the neighborhood and the Commission, the text sets forth guidelines for rehabilitating old structures and for building new ones in the Village. It is not purely a preservation document. Rather, it is intended to give residents a feel for how the Commission is likely to view the appropriateness of rehabilitation and construction plans.

The Handbook reflects the efforts of many. Past and present commissioners deserve credit for evolving the standards contained in the guidelines. Addie Morrison of the Columbus Human Services Department and intern Kevin Might made key contributions.

Ty Potterfield, the City's Historic Preservation Officer, and Mary Beth Hirsch and Barb Powers of the Ohio Historic Preservation Office were instrumental in securing a federal grant to fund the project and in providing expertise. Director Jane Schoedinger, Neighborhoods Coordinator Martha Trout, and others at the Human Services Department generously helped to distribute the Handbook.

Karen Albanese Campbell coordinated the Handbook's design and layout. Debbie Tavenner helped with proofreading and little Ben. Perhaps most important were Charlie Pace, Rick Hoehstetter, and the neighborhood volunteers who printed and bound the Handbook. Thank you, everyone.

We hope you find the Handbook entertaining, informative, and useful.

Sincerely,

**David Diroll**

David Diroll  
Commission Chairman  
Handbook Editor



---

Table of Contents

**Part I: Introduction**

I. Location of Victorian Village.....5

II. History of Victorian Village.....5

III. The Victorian Village Society .....6

IV. Character of the District.....6

V. Characteristics of Architectural Styles Present in Victorian Village.....6

    A. Italianate.....7

    B. Second Empire .....8

    C. Queen Anne.....9

    D. Richardsonian Romanesque.....9

    E. Eastlake Ornamentation .....10

    F. Vernacular.....10

        1. Princess Anne .....11

        2. American Foursquare .....11

**Part II: The Victorian Village Commission**

I. Legal Status.....12

    A. Establishment and Role of the Commission .....12

    B. City Code Provisions Governing the Commission.....12

II. Certificates of Appropriateness .....12

    A. Work Requiring a Certificate.....12

    B. Process for Receiving a Certificate of Appropriateness.....13

**Part III: Guidelines for Residential Rehabilitation**

I. Introduction to Guidelines .....14

    A. Intent of Guidelines.....14

    B. Use of the Handbook .....14

    C. Format of the Guidelines .....14

II. General Rules .....14

    A. Research and Preservation .....14

    B. Standards of the Secretary of the Interior .....14

III. Exterior Masonry .....15

    A. Architectural Character in Victorian Village .....15

    B. Cleaning Methods .....15

    C. Painted Masonry.....17

    D. Repointing .....17

    E. Chimneys.....17

IV. Siding.....18

V. Paint.....20

VI. Windows and Doors.....21

VII. Awnings and Canopies.....23

---

VIII. Roofs.....	23
A. Architectural Character in Victorian Village .....	23
B. Roofing Materials .....	23
C. Dormers.....	24
D. Gutters and Downspouts .....	24
E. Cornices and Brackets.....	26
F. Other Roof Features .....	26
IX. Porches .....	26
X. New Construction .....	27
XI. Fences and Yards.....	28
<b>Part IV: Guidelines for Commercial Rehabilitation</b>	
Appropriate Commercial Strip Rehabilitation .....	30
Storefront Rehabilitation.....	30
Storefront Signage.....	31
<b>Part V: Appendices</b>	
Appendix A Sample Application to the Commission .....	35
Appendix B Sample Certificate of Appropriateness.....	39
Appendix C Zoning Map of Victorian Village.....	41
Appendix D Glossary.....	43
Appendix E Bibliography .....	45

Part I: Introduction

I. Location of Victorian Village

Victorian village is located northwest of downtown Columbus. A neighborhood composed of over 1,000 buildings, it was designated by the City of Columbus as an historic district in 1973. It is also part of the Near North Side Historic District listed on the National Register of Historic Places in 1980, which includes additional blocks outside of the Village to the north and west.

The principal boundaries of Victorian Village are West Fifth Avenue on the north, Goodale Avenue on the south, High Street on the east, and Harrison Avenue on the west.

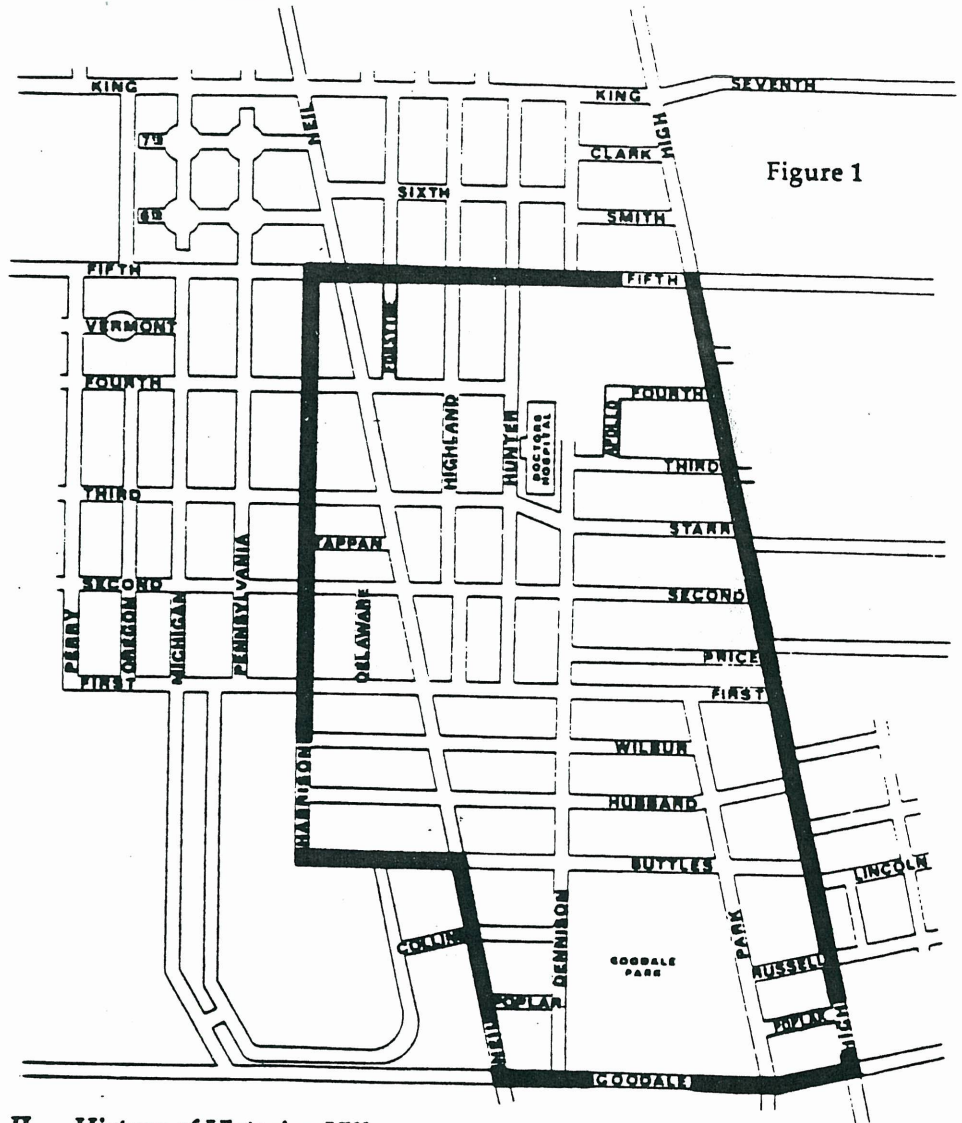

Figure 1: Victorian Village area map. The Village itself is bounded by black. Source: Terry Sherburn.

II. History of Victorian Village

Until the mid-1800's, the land occupied by Victorian Village comprised several large farms owned by the Neil, Hubbard, and Starr families, for whom streets are named. Goodale Park, the City's oldest, was donated by Lincoln Goodale in 1851.

With developments in mass transportation in the late 1800's, Columbus's downtown became more specialized as a business district. Residents moved to emerging neighborhoods nearby, including Victorian Village. Completion of a streetcar line between Goodale Boulevard and the nascent Ohio State University contributed to the residential development of Victorian Village between 1870 and 1920.

By the turn of the century, the Village was a community of diverse groups with various lifestyles, occupations, and incomes. This social mixture is reflected in the variety of architecture and housing that remain. Many prominent citizens resided in the Village during its early prosperous years along Neil, Buttles, and Dennison Avenues. Many merchants built their homes here.

The decline of the area began around 1920. The popularity of the automobile contributed to the creation of new suburbs to the north and northwest of the City.

By 1970, many structures in the Village were in desrepair. Large homes were divided in to rooming houses. Smaller houses were vacated and boarded. Many residents were transient and poor.

In the 1970's, new pioneers began to transform the neighborhood. The Victorian Village Commission and Society were created. By the mid-1980's, over 70 percent of the structures were renovated, with many returned to their original grandeur.

### III. The Victorian Village Society

The Victorian Village Society focuses on community service issues and social events. The society hosts several community events every year including the Tour of Homes. The Society produces a monthly newsletter that is distributed to its members and other people who live in the area. The Society is open to all people who reside, own property, rent property, or operate a business in the Village. The Society generally meets at 7 p.m. on the third Thursday of each month at Hunter House, 1013 Hunter Avenue.

### IV. Character of the District

The buildings in the Victorian Village historic district are generally single and multi-family dwellings. Also, the Village has churches, medical, recreational, and educational facilities, and professional offices. Commercial buildings line High Street.

Most of the structures in the Village are detached residences, two or three stories in height. Brick and stone predominate, but many buildings have wood siding. Hipped and gabled roofs, dormers, ornamentation, corbelled chimneys, decorated porches, and a variety of window shapes, some with stained and leaded glass, add to the character of the buildings. Some surviving carriage houses and garages line the alleys.

### V. Characteristics of Architectural Styles Present in Victorian Village

This section, contains an overview of the architectural styles found in Victorian Village. The descriptions are not to be construed as guidelines. Specific guidelines for residential and commercial rehabilitation are found in Parts III and IV.

The term "Victorian" often is misused to represent an architectural style. Actually, the term describes the types of architecture popular during the later years of the tenure of Britain's Queen Victoria, who reigned from 1837 to 1901.

The Victorian period produced many different styles of architecture. Examples found in Victorian Village include Italianate, Second Empire, Queen Anne, and Richardsonian Romanesque. Other styles, such as Victorian Gothic, occur in Victorian Village, but are less common.



The  
**VICTORIAN  
VILLAGE**  
Society



Figure 2: Victorian Gothic house  
at 755 Dennison Avenue.  
Photograph by Greg Miller.

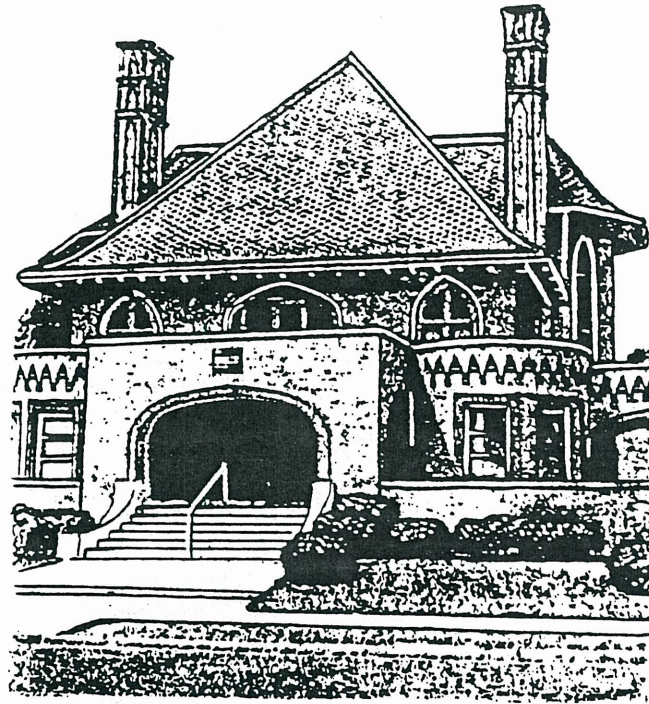

Figure 2

The architecture of the Victorian period often displays extravagant use of complex shapes and elaborate detailing made possible by improved building technologies (the balloon frame, mass-produced ornamentation, etc.), improved shipping via railroads, and greater information on stylistic trends through the distribution of pattern books, trade magazines, and the like. Victorian architecture is typified by variety in materials, colors, textures, floorplans, and building shapes.

Familiarity with Victorian styles discussed below is important to understanding the architecture of Victorian Village. However, knowledge of post-Victorian trends also is relevant. Victorian flamboyance was tempered by a utilitarian movement in early Twentieth Century American architecture. Thus, while most Victorian Village structures find their origins in Victorian styles, few are textbook examples of these styles. Structures built after 1900 often fall into what the *Old House Journal* calls the "Princess Anne" or "Foursquare" styles, which are described in the section on Vernacular styles.

#### A. Italianate

Influenced by vernacular houses of the northern Italian countryside, the Italianate style was popular in the United States from the Civil War until the early Twentieth Century. The picturesque qualities of the Italianate style were popularized in America by pattern books such as those by Andrew Jackson Downing.

Italianate houses typically are symmetrical, rectangular structures, two or three stories high. Low, hipped roofs with wide eaves supported by large, often paired, brackets contribute to the detailing of this style. Tall, narrow windows, often grouped together, are common, especially on the first story. Windows may have elaborate carved crowns, which may be pedimented, rectangular, or arched. Detailed entrances are common. These often are characterized by paired doors, either rectangular or arched, and small entry porches with beveled wood columns and enframements above doors similar to, but more pronounced than, window crowns. Some Italianate buildings have belt courses between floors and Classical quoins that define corners. Italianate is a common house, rowhouse, and storefront design in Victorian Village.

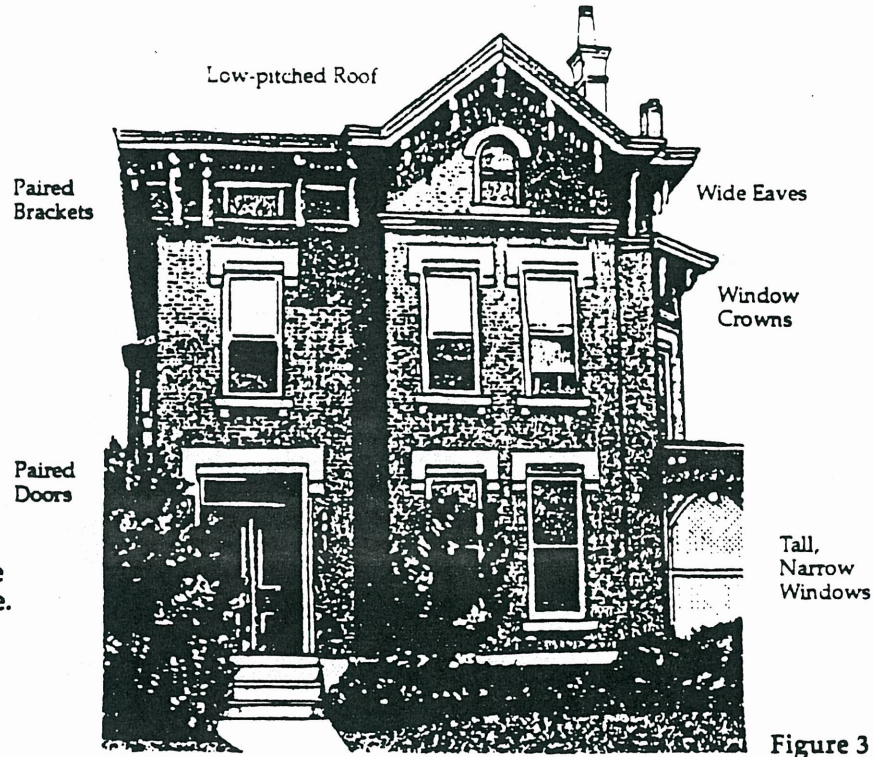

Figure 3: High Italianate style house at 76 West Starr Avenue. Photograph by Greg Miller.

Figure 3

#### B. Second Empire

Along with Italianate and Gothic Revival, the Second Empire style was part of the Nineteenth Century's Romantic Picturesque movement. Second Empire buildings were popular into the 1880's in the United States. The style's signature characteristic, setting it apart from purely Italianate structures, is the steeply sloped French mansard roof, usually containing dormers.

Otherwise, Second Empire buildings are similar in overall shape, mass, and decoration to Italianate structures. They have a strong three-dimensional appearance. Surfaces prominently project and recede. The facade usually is symmetrical. Tall decorated chimneys are common, as are wide cornices with brackets, paired windows, double doors, paired porch columns, belt courses, and Classical pediments. Second Empire influences are seen on several rowhouses in Victorian Village and on a few single-family dwellings.

Figure 4: Second Empire house showing characteristic features. Source: McAlester.



Figure 4

### C. Queen Anne

The Queen Anne style was introduced to the United States by English architect Richard Norman Shaw, whose work was widely published in architectural journals. The British Exposition Building at the 1876 Centennial Exposition in Philadelphia helped create an appetite for the style in America that was not sated until the 1910's. Historically, the style's name is misleading since Shaw's work had little to do with the formal, neo-Classical, Renaissance architecture of Queen Anne's reign (1702-19).

This style is distinctive for its varying textures and colors. For example, brick may be used on one story, shingle on another, and horizontal boards on a third. Yet, the overall facade retains a vertical appearance. A steeply pitched roof, usually with a dominant gable in the front, characterized this style. Queen Anne buildings are asymmetrical and eclectic. "L"-shaped porches that run across the front and one side of Queen Anne houses are common, as is decorative woodwork such as lattice and turned balusters and posts. Queen Anne houses may contain a round or polygonal tower, both gabled and hipped roofs on the same structure, finials and other roof decorations, stained glass windows, often in small squares outlining upper sashes, and stained glass transoms. There are many examples of Queen Anne architecture in Victorian Village. Its descendent, the "Princess Anne" style, is one of the Village's most common house styles.

Figure 5: Queen Anne house with Eastlake ornamentation at 1265 Neil Avenue.

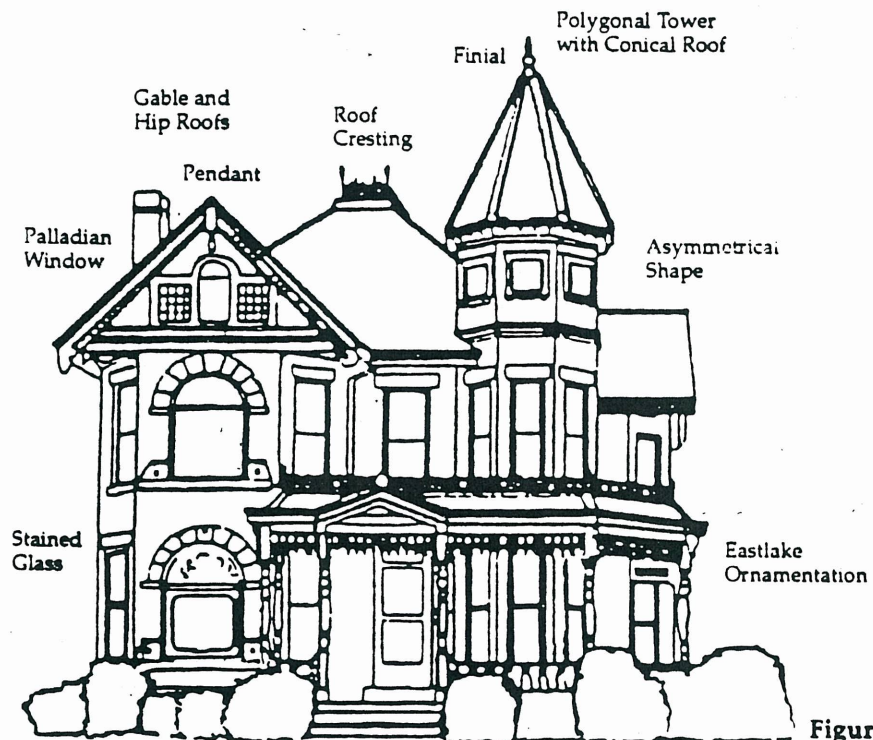

Figure 5

### D. Richardsonian Romanesque

This style was popular around the turn-of-the-century. It is largely the invention of American architect Henry Hobson Richardson (1836-86), who also is known for his work with the Shingle Style.

Richardson Romanesque buildings are characterized by multi-colored stone finishes, boulder-like masonry laid with wide joints of rose tinted mortar, and semicircular arches at entrances and over windows. Squat columns, occasionally paired, are used to support the arches. Stone that contrasts with the body of the structure in color, texture, and placement is used to highlight the window and

door openings. Most Richardsonian houses have one or more cross gables, sometimes accompanied by a round tower with a conical roof. Richardsonian houses are always made of stone and appear dense, weighty, and permanent. There are relatively few Richardsonian buildings in Victorian Village.

Figure 6: Richardsonian Romanesque house at 1163 Neil Avenue.

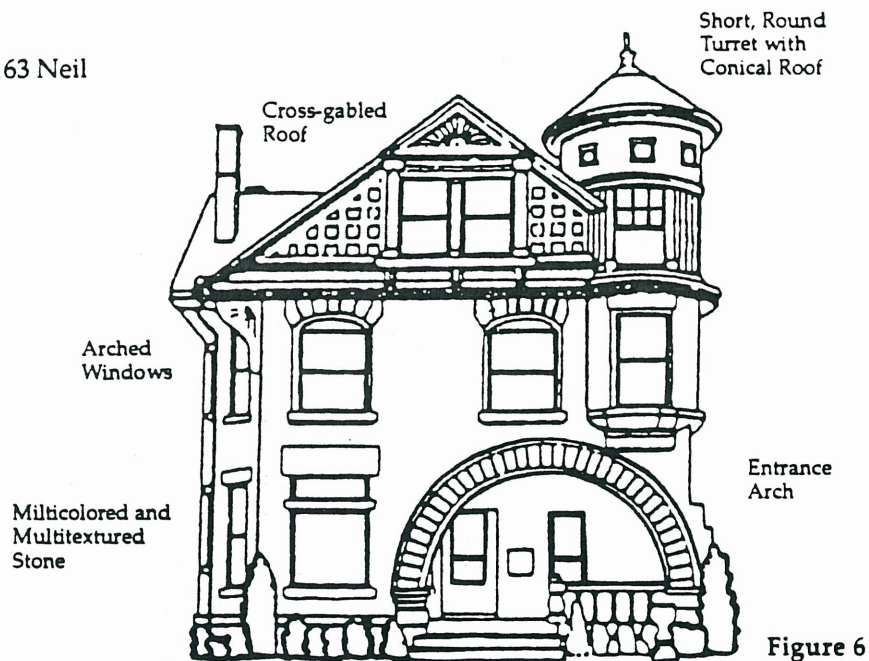

Figure 6

#### E. Eastlake Ornamentation

Eastlake is a decorative style of ornamentation found on many Victorian houses, especially those of the Queen Anne style. The style is named after Charles Locke Eastlake, an English designer whose popular book, *Hints on Household Taste*, was published in the United States in 1872.

Eastlake ornamentation is characterized by furniture-like elements including knobs, decorative motifs with circular perforations, heavy brackets, and large, turned porch balusters and posts that resemble table legs. Eastlake design is common in Victorian Village.

#### F. Vernacular

Design leaders in the early Twentieth Century began to rebel against the flourishes of Victorian architecture. A yearning for a more "American" architecture spawned the Colonial Revival movement. Colonial Revival is a symmetrical style that accentuates a building's entrance by using decorative crowns, fan-like transoms, and sidelights. The rest of the structure retains a fairly plain appearance. Next came the Neoclassical movement, which revived Classical columns and pediments over porches, above windows, and over dormers. Independent of the philosophic concerns of these movements, working class people often found Victorian houses too expensive to build.

The term "Vernacular" is used to classify structures that are not textbook examples of a particular style, but contain some of the features of one or more of the styles discussed above. Most houses in Victorian Village fall into the Vernacular category. They include descendants of Victorian styles and Post Victorian structures that reflect the changing philosophies of the early Twentieth Century and incorporate Colonial Revival or Neoclassical features. Victorian Village Vernacular houses built at the beginning of the Twentieth Century typically fall into one of two categories: "Princess Anne" or the "Foursquare".

Figure 7

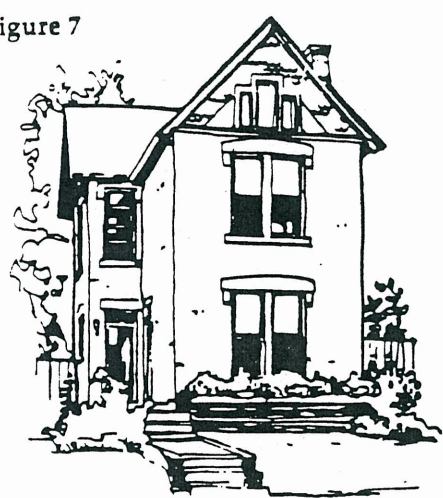

Figure 7: Typical Vernacular Victorian house showing Queen Anne and other influences at 1035 Hunter Avenue. Drawing by Don Slobodien.

1. Princess Anne

The Princess Anne style is the less radical departure from high Victorian architecture. It is a simpler descendent of the Queen Anne style. The asymmetrical shape, complex roofline, large chimneys, and some of the Eastlake decoration characteristic of Queen Anne style are retained by Princess Anne structures. However, towers were eliminated and the amount of exterior ornamentation was reduced. Princess Anne houses tend to be smaller than their ancestors. This overlooked style is quite common in Victorian Village.

2. American Foursquare

The American Foursquare is a more dramatic reaction against Victorian excess than the Princess Anne style. Although seldom discussed in books on American architecture, the Foursquare probably was the most popular house style built in American cities during the post-Victorian period. Many houses were erected in this style in Victorian Village.

Foursquare houses typically have a nearly square, box-like appearance, flat walls, two full stories capped by a third story containing one or more large dormers (although not more than one per side), low hipped roofs, and a prominent porch that spans all or most of the front of the house. Some porches contain Classical columns, usually with Doric capitals, simple round rails, and no spindles. Others bear Eastlake porch posts and spindles, but little decoration elsewhere on the exterior. Colonial Revival entrance treatments sometimes are seen on these houses in Victorian Village. But, generally, doors and windows are simple. Windows may vary in size and shape; symmetry may occur, but is not required. In Victorian Village, most Foursquare houses are brick.

Figure 8: Foursquare at 1045 Hunter Avenue. Drawing by Don Slobodien.



Figure 8

Part II: The Victorian  
Village Commission



I. Legal Status

A. Establishment and Role of the Commission

The Victorian Village Commission was established in 1973 by the Columbus City Council. The Commission is the agency of City government that deals with preserving the architectural integrity of the Village. It holds regular meetings to review plans for exterior changes to structures in the Village, review construction plans, and make recommendations on issues such as requests for zoning variances and changes. The Commission formally represents the Village before City Council and other agencies.

B. City Code Provisions Governing the Commission

The Columbus City Code specifies that the Victorian Village Commission consists of nine members appointed by the Mayor to serve three-year terms without compensation.

The Code makes clear that a Certificate of Appropriateness must be obtained from the Commission before doing any work, other than routine maintenance, on the exterior of any structure in the Village.

A building permit for work in Victorian Village cannot be granted by the City until the Commission has approved the proposed construction.

The Code gives the Commission broad discretion to pass on the appropriateness of any application for a Certificate. In deciding whether to issue a Certificate, "the Commission shall consider, in addition to any other pertinent factors, the historical and architectural value and significance, architectural style, general design, arrangement, texture, material and color of the exterior architectural factors of other structures in the immediate neighborhood." (Sec. 3331.08.)

Anyone who constructs, reconstructs, alters, or demolishes the architectural features of any structure in Victorian Village is guilty of a misdemeanor if the work was not approved by the Commission. A fine of \$50 to \$5,000 may be imposed on violators. Anyone who demolishes all or a substantial part of a Victorian Village building without Commission approval may be fined \$10,000 to \$25,000. Even stiffer penalties may be applied when a property owner willfully neglects to maintain his property. The owner may be required to restore or reconstruct the building.

II. Certificates of Appropriateness

A. Work Requiring a Certificate

Examples of work in Victorian Village that require a Certificate issued by the Commission include, but are not limited to:

1. Construction or exterior renovation of structures including houses, carriage houses, garages, sheds, fences, display signs, and other structures (structure is defined to include these and other constructs in Section 3331.03 (b) of the Columbus City Code);
2. Additions to existing structures, such as new rooms that alter the exterior, porches, decks, and skylights;
3. Exterior painting if any colors are changed;
4. New doors, windows, storm doors, storm windows, gutters, and roofing;
5. Removal of existing siding and its replacement with a different material or the placement of any new siding over old;

Figure 8A



Figure 8A: Hunter House, a simple Italianate structure at 1013 Hunter Avenue, serves as the meeting place for the Victorian Village Commission and Society.

6. Cleaning and tuckpointing of masonry;
7. Demolition of all or part of any structure;
8. Any other changes that would alter the exterior appearance of a structure.

**B. Process for Receiving a Certificate of Appropriateness**

1. The Commission meets on the fourth Thursday of each month. It also meets on the second Thursday of May through September. Meetings are held at 6:30 p.m. at Hunter House, 1013 Hunter Avenue.

A prospective applicant should contact the Commission secretary at least one week before the meeting at which the applicant wishes to be heard. The secretary will provide the applicant with a formal application and relevant information. (A sample application is contained in Appendix A.) The secretary will place the applicant's project on the meeting agenda. Failure to contact the secretary before the meeting may delay consideration of the application.

2. An applicant should provide the following materials at the time of application:
  - a. Current color pictures of the property or structure;
  - b. Paint and color samples, when relevant;
  - c. Samples of, or manufacturers' brochures for, products such as shingles, siding, brick, windows, doors, awnings, gutters, and fences, when relevant;
  - d. For minimal alterations, a simple drawing of, or written specifications for, the proposed work;
  - e. For new construction or extensive alterations, a set of construction drawings including a site plan, exterior elevations, landscape plan, and exterior detail drawings. If a building permit is needed, three sets of drawings must be presented to the Commission;
  - f. Renderings of any graphics, when relevant;
  - g. For demolitions, plans for what will replace the structure and a written reason for the demolition.
3. Once on the agenda, the applicant must appear at the Commission meeting and verbally explain the work to be done. The Commission may have questions or suggest modifications. Some applications are tabled for further review at a later meeting. A few applications are denied. Most applications are approved by the Commission in some form, and a Certificate of Appropriateness is prepared and mailed to the applicant. The language of the Certificate, not of the application, governs the work to be done.
4. A sample Certificate of Appropriateness is contained in Appendix B.

### Part III: Guidelines For Residential Rehabilitation.

#### I. Introduction to the Guidelines

##### A. Intent of Guidelines

1. To provide the property owners in Victorian Village with guidance on restoring, rehabilitating, and building structures in the Village in cooperation with the Victorian Village Commission.
2. To maintain the architectural character and compatibility of structures in Victorian Village.
3. To preserve the economic value of the properties in the Village.

##### B. Use of the Handbook

1. A guide for sensitive rehabilitation and restoration of the exterior of buildings in the Village.
2. A guide to the construction of compatible new structures in the Village.
3. An informative resource on the Commission's criteria for issuing a Certificate of Appropriateness.

##### C. Format of the Guidelines

1. The guidelines set forth general rules. They are divided into broad topics and list treatments that are typically viewed as "appropriate" or "not appropriate" by the Victorian Village Commission. The guidelines are not absolute. Rather, they are designed to give general guidance to property owners. Decisions as to what is appropriate are made by the Commission on a case-by-case basis.
2. When deciding whether to issue a Certificate of Appropriateness, the Commission looks at the appropriateness of the structure's height, scale, rhythm (solids to voids, projections), colors, textures, and materials. The Commission looks at the structure itself and its relationship to neighbors.

#### II. General Rules

##### A. Research and Preservation

Property owners should research the history of their properties before undertaking restoration or rehabilitation in Victorian Village. The primary goal is to ascertain original features and preserve or reconstruct them.

##### B. Standards of the Secretary of the Interior

The Secretary of the United States Department of the Interior has set forth Standards for Rehabilitation of Historic Structures. The Victorian Village Commission encourages compliance. Compliance is required to obtain federal tax credits for the rehabilitation of income-producing properties.

The Secretary of the Interior's Standards are as follows:

1. Every reasonable effort shall be made to provide a compatible use for a property which requires minimal alteration of the building structure or site and its environment, or to use a property for its originally intended purpose.
2. The distinguishing original qualities or character of a building, structure, or site and its environment shall not be destroyed. The removal or alteration of any historic material or distinctive architectural features should be avoided when possible.



3. All buildings, structures, and sites shall be recognized as products of their own time. Alterations that have no historical basis and which seek to create an earlier appearance shall be discouraged.
4. Changes which may have taken place in the course of time are evidence of the history and development of a building, structure, or site and its environment. These changes may have acquired significance in their own right, and this significance shall be recognized and respected.
5. Distinctive stylistic features or examples of skilled craftsmanship which characterize a building, structure, or site shall be treated with sensitivity.
6. Deteriorized architectural features shall be repaired, rather than replaced, wherever possible. In the event replacement is necessary, the new material should match the material being replaced in composition, design, color, texture, and other visual qualities. Repair or replacement of missing architectural features should be based on accurate duplication of features, substantiated by historic physical or pictorial evidence rather than on conjectural designs or the availability of different architectural elements from other buildings.
7. The surface cleaning of structures shall be undertaken with the gentlest means possible. Sandblasting and other cleaning methods that will damage the historic building materials shall not be undertaken.
8. Every reasonable effort shall be made to protect and preserve archaeological resources affected by or adjacent to any project.
9. Contemporary design for alterations and additions to existing properties shall not be discouraged when such alterations and additions do not destroy significant historical, architectural, or cultural material, and such design is compatible with the size, scale, color, material, and character of the property, neighborhood, or environment.
10. Wherever possible, new additions or alterations to structures shall be done in such a manner that if such additions or alterations were to be removed in the future, the essential form and integrity of the structure would be unimpaired.

### **III. Exterior Masonry**

#### **A. Architectural Character in Victorian Village**

A substantial number of structures in Victorian Village have exterior walls made of brick or stone with important decorative features such as terra cotta, brick, or multi-colored stone trim that should be preserved to maintain the character of the buildings.

#### **B. Cleaning Methods**

Cleaning masonry and siding generally is unnecessary to preserve a building. Therefore, it is often discouraged. However, if it is to be undertaken, it is important that the cleaning not damage the building.

##### **1. Water Spray or Steam Cleaning**

###### **a. Technical Information**

Water spray is a relatively simple and low-cost method of cleaning. The purpose is to keep deposits of dirt moist long enough for them to soften, thereby allowing them to be removed by either hosing them down at less than 300 pounds per square inch pressure or using bristle brushes. This method is effective for brickwork when the dirt is on the surface. It poses little threat to building materials. When there is no need for

harsher methods of cleaning, the water spray method has relatively few disadvantages. The primary ones are that limestone may develop stain and that water used in large volumes may damage interior finished, hidden timbers, and ferrous metal. Excess water also can release soluble salts from within masonry forming white deposits on the surface called efflorescence.

**b. Appropriate**

- (1) To clean painted wood or surface dirt on masonry.
- (2) To avoid damaging masonry.

**c. Not Appropriate**

- (1) To remove all heavily encrusted dirt, which necessitates removing part of the brick surface, thereby irreparably damaging it.
- (2) To clean a building that is not in sound condition.

**2. Chemical Cleaning**

**a. Technical Information**

There are a number of chemical cleaners available that offer low cost and efficient cleaning. Many of them have the advantage of being able to remove paint from brick, stone, and wood surfaces. All chemical cleaners, however pose some risk to the building, the surrounding soil, plants, and the users of the chemicals. They should be applied with caution. Also, chemical cleaners may change the color of masonry.

**b. Appropriate**

When used instead of sandblasting to remove paint from brick, stone, and wood surfaces.

**c. Not Appropriate**

When used on masonry such as marble and limestone that are dissolved by acidic cleaners.

**3. Sandblasting**

**a. Technical Information**

Along with dirt, sandblasting removes the outer surface of brick, leaving it porous and pitted, leading to further deterioration from over-exposure to weather. Mortar joints also may be damaged in the process. As a result, complete repointing is almost always needed afterwards, even though the wall might not have required it before being sandblasted. Sandblasting can cause the loss of delicate features in detailed carvings and damage polished surfaces. It is especially harsh on soft stone. From a historic perspective, sandblasting greatly reduces the value of the building.

**b. Appropriate**

- (1) In rare circumstances, cleaning hard stone accompanied by repointing of the wall surface.
- (2) To remove stucco from a surface when the stucco is not historically appropriate.

**c. Not Appropriate**

- (1) To clean brick surfaces in most circumstances.
- (2) To clean soft stone.

Figure 9

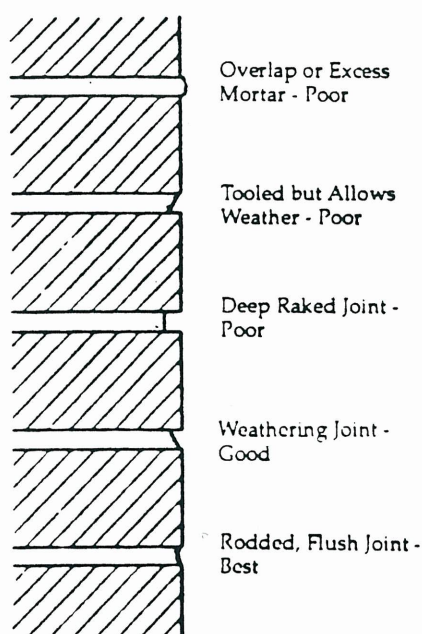

Figure 9: Types of brick joints. Source: Cape May Guidelines.

## C. Painted Masonry

### 1. Technical Information

If researching the history of the building proves that the masonry was painted historically, maintaining the paint may be more appropriate than exposing the brick. Even in cases where exposed masonry is historically appropriate, retaining paint may be more desirable than removal because of the harshness of the cleaning process.

### 2. Not Appropriate

Sandblasting

## D. Repointing (Tuckpointing)

### 1. Technical Information

Repointing is the process of replacing missing and defective mortar in brick and other masonry walls. It is needed not only for visual reasons but also to prevent water leakage in the walls.

Usually old mortars were composed of sand and lime with very small portions of cement. Lime mortars and hydraulic cements generally are preferred for tuckpointing old structures. Mortars must be softer than bricks and allow bricks to expand and contract as temperatures vary. Portland cement, when used alone or in large quantities, can cause permanent damage to older buildings because it is more rigid and less porous than the original mortar. These qualities cause different rates of expansion and contraction and can result in cracked or spalled masonry. Also, portland cement is difficult to remove without harming the original materials because it bonds strongly to the masonry.

### 2. Appropriate

- a. Careful removal of loose mortar without damaging the edges of the brick. New mortar to match the old in composition, color, and joint profile.
- b. Careful finishing of new joints in order not to make them wider than the old ones. Joints slightly recessed to allow for expansion when the temperature rises.
- c. Replacement bricks that match the original undamaged brick in size, shape, color, and texture.

### 3. Not Appropriate

Mortar that does not approximately match the original in color and composition, especially when the entire wall is not being repointed.

## E. Chimneys

### 1. Architectural Character in Victorian Village

Historically, a chimney was a chute for smoke, fumes, and heat from a fireplace or furnace. Therefore, it is an integral part of the building. In addition, a chimney acts as a design element, often incorporating unusual brick patterns and details. Tall chimneys are common in Victorian Village. Some decorative chimney pots and corbelled brickwork add to their character.

### 2. Appropriate

- a. Rebuilt to duplicate chimneys present on the building at the time the building was constructed.
- b. New chimneys constructed similar to existing historically appropriate ones when building a structure or an addition.

- c. New chimneys constructed of brick masonry that is compatible with the architectural character of the Village and the other materials, colors, forms, and textures of the structure.

## 2. Not Appropriate

- a. Altering the height of original chimneys.
- b. Removing details from chimneys including corbelling, stone coping, carved details, and chimney pots.
- c. Painting chimneys that have never been painted.
- d. Covering chimneys with stucco.
- e. Covering existing chimneys with wood, vinyl, or aluminum cladding.
- f. Exposed metal flues instead of brick and stone chimneys unless historically appropriate.

Figure 10

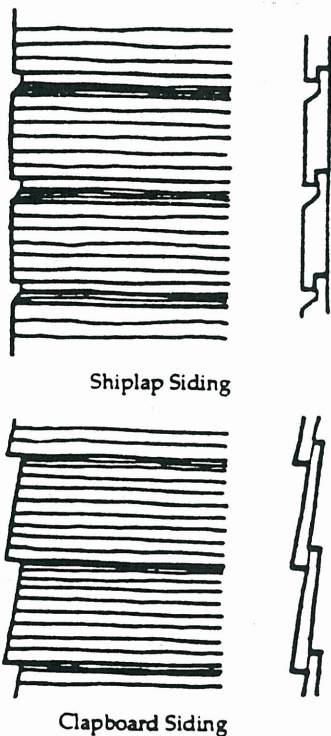

Figure 10: Historic sidings.

## IV. Siding

### A. Architectural Character in Victorian Village

Many structures in Victorian Village are wood-sided, frame buildings exhibiting a variety of surface textures. Two types of wood siding predominate. One is shiplap siding (strips of wood pieced together to result in the appearance of a flat wall with horizontal grooves). The other is clapboard siding (narrow, horizontal strips of wood, slightly thicker at the bottom, that overlap). Each type is accompanied by vertical boards at each corner of the building. Wood shingles and vertical board and batten styles occur in Victorian Village, but are rare and generally discouraged by the Commission unless warranted historically.

### B. Technical Information

Wood frame structures that need extensive maintenance or repair may require application of new siding. Wood siding is preferred. The style depends on the historic style used on the building. Aluminum or vinyl siding may be approved in some cases, if applied properly. However, wood siding often appears to be in worse condition than it actually is. Individual warped and split boards can be replaced with new ones of similar proportions.

Negative effects of the application of aluminum or vinyl siding to historic buildings include:

1. The historic appearance of the building is altered by changes in proportion, texture, and color. This results from changes in clapboard spacing, trim removal, and the alteration or replacement of windows. Even when trim is retained, the use of substitutes destroys the basic integrity of historically and architecturally significant buildings and may lessen their economic value.
2. Moisture problems occur behind unvented aluminum or vinyl siding because the walls of historic buildings usually are uninsulated. The moisture produced inside travels through the wall cavity to the exterior, especially in the winter. When an impermeable layer of siding is applied to the exterior, moisture is trapped in the wall cavity creating conditions favorable to deterioration due to wood rotting. Moreover, leaking gutters and downspouts may allow excessive moisture to flow behind the artificial siding undetected.

Figure 11

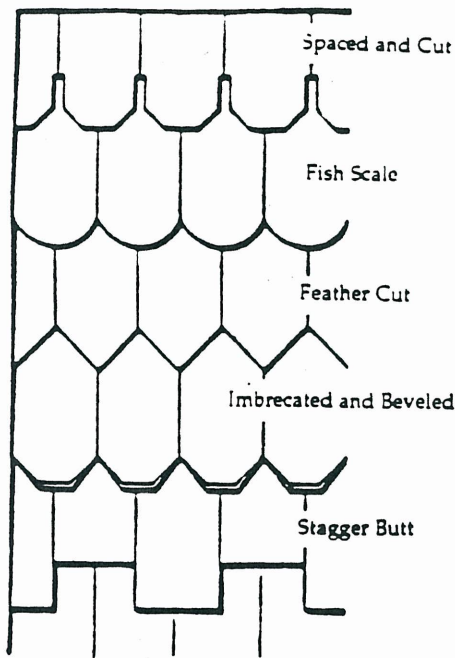

Figure 11: Types of cut wood or artificial siding shingles. Source: Cape May Guidelines.

3. Vinyl or aluminum siding impedes regular inspection of the underlying material preventing early detection of signs of insect damage and other deterioration.
4. Aluminum siding is easily dented and scratched. Vinyl siding is easily torn and may be shattered in cold temperatures. These wounds detract from the historic appearance of the structure and may be expensive to repair. Also, the color of aluminum and vinyl sidings may fade. Both are expensive to paint and neither has the proven life expectancy of properly maintained wood siding.

C. Appropriate

1. Repair and retention of shiplap and clapboard siding depending on the style originally used.
2. New materials that duplicate the size, shape, and texture of the original materials as closely as possible.
3. Restoration of frame structures that have been covered with "Insulbrick" shingles, wood shakes, artificial brick, or brick or stone veneer to their original condition.
4. Preserving or duplicating wood structural elements and decorative details including those made with hand tools.
5. Vertical board and batten details on cottage designs and outbuildings where historically appropriate.
6. Where aluminum or vinyl siding is approved:
  - a. Siding with the appearance of shiplap or clapboard in 3" or 4" slats depending on the profile of the original.
  - b. Smooth rather than textured siding.
  - c. Window, door, corner boards, and other trim work built out to maintain a three dimensional rather than flat appearance.
  - d. Restoration of all wooden details such as porch columns and decorative trim rather than covering with aluminum or vinyl.
7. Use of cut wood shingles, or synthetic shingles having the appearance of cut wood shingles, when historically appropriate.

Figure 12: Source: Italian Village Guidelines.

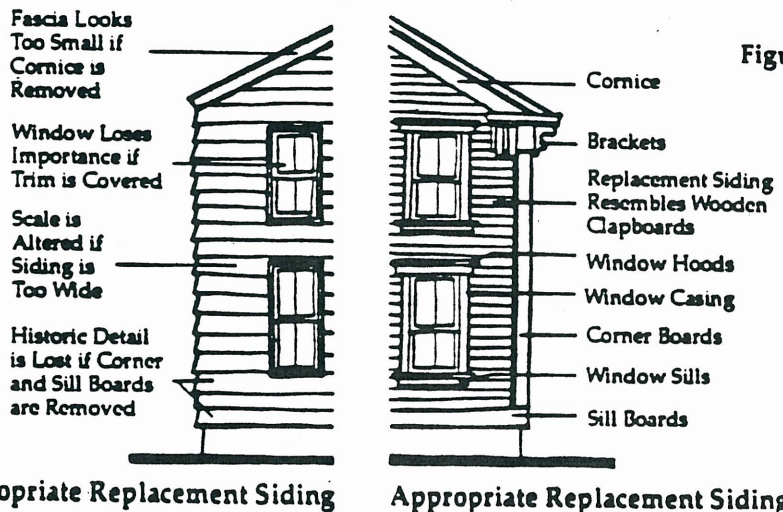

Figure 12

Inappropriate Replacement Siding

Appropriate Replacement Siding

#### D. Not Appropriate

1. Covering or removing shiplap or clapboard siding for ease of maintenance.
2. Covering or removing special details such as "fish scales" and "ginger-bread", especially in gables.
3. Use of "Insulbrick", shakes, artificial brick or stone veneer or other materials that alter the historic appearance of the structure.
4. When new siding is installed over old, failure to build out door and window frames.
5. Siding slats wider than 4" with rare exceptions justified by the original siding.
6. Textured rather than smooth siding.
7. Diagonal or vertical siding over large expanses.
8. Plywood and similar substances manufactured to simulate board and batten texture.
9. The use of "clapboard" vinyl or aluminum siding over historic shiplap siding.
10. Covering wood siding with aluminum or vinyl without first obtaining an estimate of the repair cost of the historic wood siding.

Figure 13

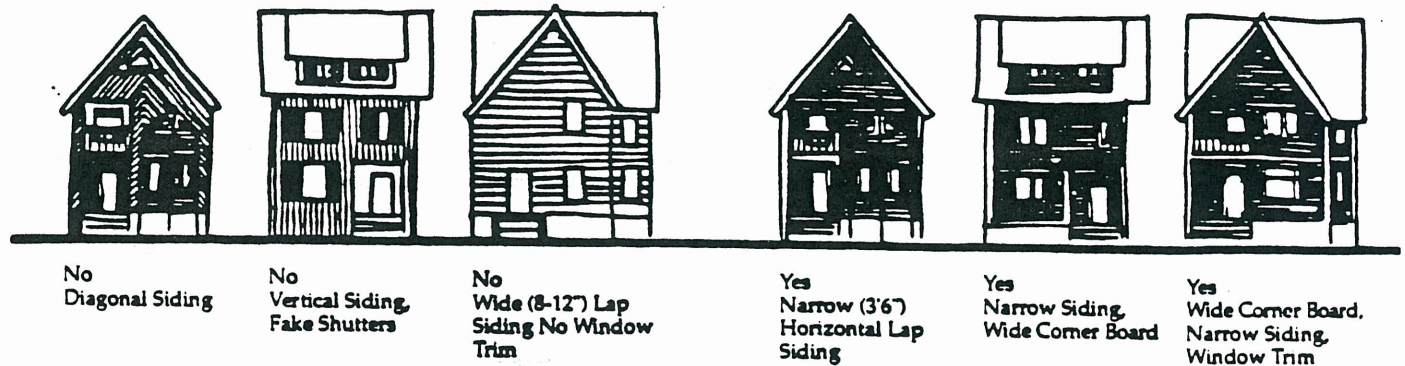

Figure 13: Source: Gainesville, Florida Guidelines.

#### V. Paint

##### A. Architectural Character in Victorian Village

In the 1860's and 1870's, soft colors were used for houses in the Italianate style. Color grew bolder in the late 1800's. Houses in the Eastlake and Queen Anne styles were painted in dark, rich colors, such as dark green, Indian red, and brown.

One of the most important decisions building owners make is the choice of exterior paint colors. This is of particular importance in the case of a wood frame building where the combination of wall trim colors usually determines its basic character, making it appear either cheerful or gloomy, light or heavy, restful or busy. In the case of a brick building, although the basic wall color has already been established (unless the brick has been painted), the choice of color for windows, doors, trim, and other features can still affect the character of the exterior.

The first step in color selection is to research the historic colors of the structure. Paint analysis may aid this inquiry.

Figure 14

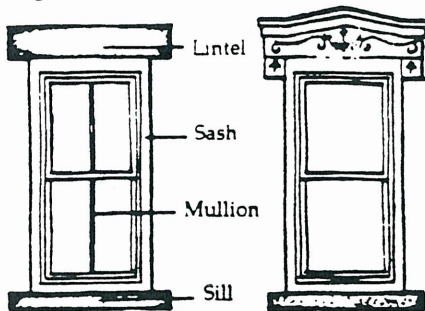

Figure 14: Typical Victorian Village windows.

### B. Technical Information

Paint is applied to exterior wood surfaces to protect them from the deteriorating effects of weather. Careful preparation of the surface before painting is very important. Complete removal of old paint should be avoided unless absolutely necessary for proper adhesion of new paint. Often, scraping and sanding are sufficient to remove loose paint.

### C. Appropriate

1. Research into, and use of, the original color scheme used on the house.
2. Variety in paint colors. Two main colors, one for the body of the house and one for the trim, and sometimes one accent color. In houses with large amounts of decorative trim work, a second or even third accent color can be used if carefully selected.
3. Repair sources of moisture problems before repainting.

### D. Not Appropriate

Using blow torches, sandblasting, water cleaning with over 600 pounds per square inch of pressure, rotary sanders, or rotary wire strippers to remove paint.

## VI. Windows and Doors

### A. Architectural Character in Victorian Village

Most first and second story windows in Victorian Village are double hung sash windows with a height-to-width ratio of two-to-one or greater. Italianate and Second Empire buildings often have narrower, taller windows on the ground floor. Windows in many Vernacular residential and commercial structures are set in pairs. The gables of Queen Anne and Vernacular buildings tend to have shorter windows that are closer together than elsewhere on the structures, but still retain a vertical look. Wooden doors predominate. Doors are usually of the four-panel design. Glass or double-entry doors with matching patterns are seen, especially in Italianate structures.

### B. Appropriate

1. Preserving original doors, windows, and transoms. Replacement windows sized to fit original window openings.
2. The height, width, and spacing of doors and windows compatible with similar structures nearby.
3. Original ornamentation around the door or window is kept. If the original is missing or if it is too deteriorated to save, restoration or replacement in a way that preserves the appearance of the original trim.
4. If a window sash is too rotted to repair, installation of comparable replacement sash.
5. Preserving stained or leaded glass windows.
6. Storm windows and doors that do not attract notice.

### C. Not Appropriate

1. Flat doors or those that have more than six panels.
2. Windows smaller or larger than originals
3. Windows hinged at the top or sides, with occasional exceptions in gables and landings.
4. Mirrored or tinted glass in windows or doors.



Figure 18

Figure 15

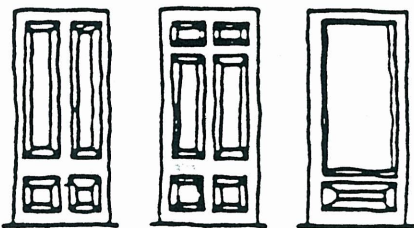

Figure 15: Appropriate doors

Figure 16

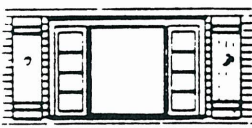

Figure 16: Inappropriate window ensemble: size and design not appropriate, batten shutters secured to wall.

Figure 17



Figure 17: Inappropriate storm door and surroundings. Source: Cape May Guidelines.

Figure 18: Appropriate storm door on original entry. Source: Cape May Guidelines.

Figure 19

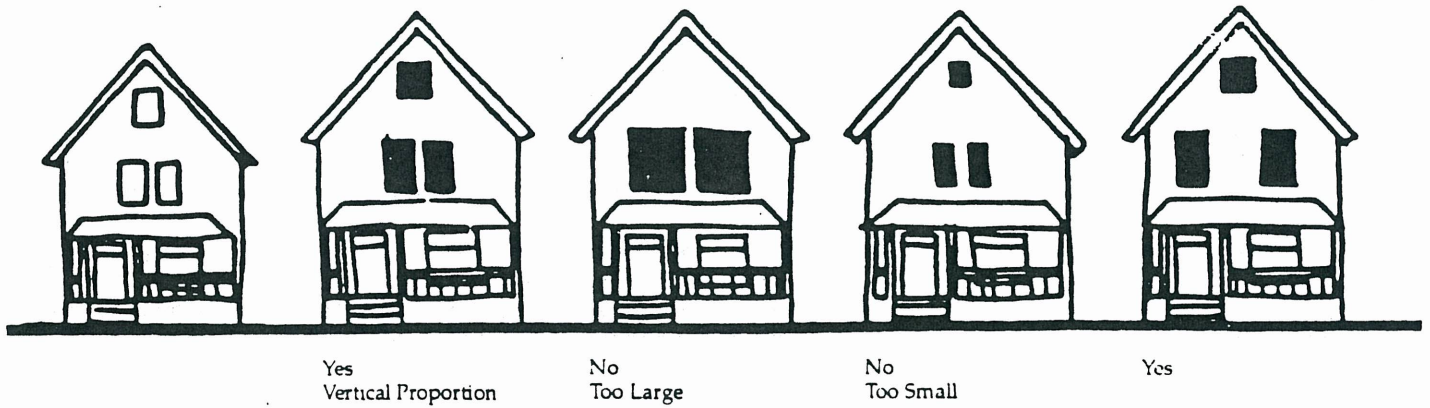

Figure 19: Source: Gainesville, Florida Guidelines.

**D. Shutters**

**1. Architectural Character in Victorian Village**

Exterior wood shutters served both decorative and functional purposes on some styles of buildings constructed in the district. Viewed from the exterior, open shutters provide a balancing effect between windows and wall spaces, give an increased vertical appearance, and differentiate a large wall expanse. Louvered shutters are the most common.

**2. Appropriate**

- a. Use of shutters if the building had them originally. (Whether the building had shutters originally can be determined by checking the window casings for remaining hinge pins or notches in the wood where mountings could have been located.)
- b. Operable shutters or those having the appearance of being operable.
- c. Shutters that extend from the lintel to the sill exactly. Shutters that appear to close completely over the window, but not over the lintel or sill.
- d. Shutters made of wood are preferred.

**3. Not Appropriate**

Shutters larger or smaller than the dimensions of the window opening.

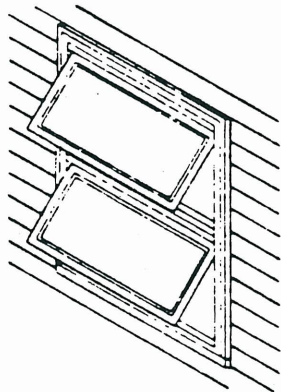
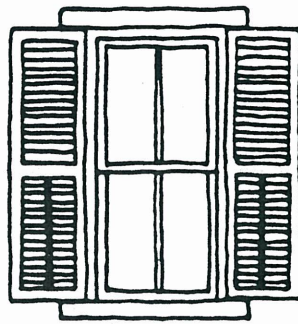

Figure 20

Figure 20: Modern awning type window - not appropriate as replacement. Source: Cape May Guidelines.



Appropriate Shutter

Figure 21

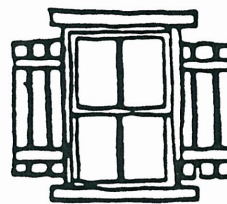

Inappropriate Shutters

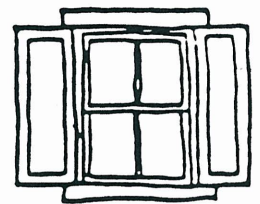



## VII. Awnings and Canopies

### A. Architectural Character in Victorian Village

Awnings and canopies shield doors and windows from the elements and provide decorative accents. Awnings also are a temporary solution when more formal porch treatments are not feasible. They should not be viewed as permanent solutions unless research shows they appear historically. In approving awnings, the Commission presumes they will be cleaned regularly and replaced when they become faded or tattered.

### B. Appropriate

1. Awnings and canopies in accent colors that are compatible with the main structure and trim.
2. Awnings that shade front porches or stoops, windows, and storefronts.

### C. Not Appropriate

1. Metal awnings.
2. Awnings and canopies that cover or damage any important ornamentation.

## VIII. Roofs

### A. Architectural Character in Victorian Village

Houses and garages in Victorian Village typically have hip or gabled roofs. Dormers are common on larger homes. Some houses and rowhouses have mansard roofs. Most rowhouses and commercial buildings have flat roofs with decorative parapets.

Figure 22

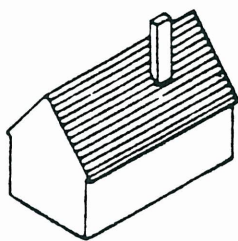

Gabled Roof

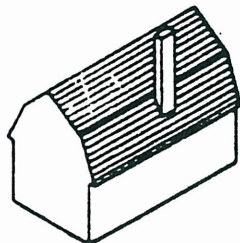

Gambrel Roof

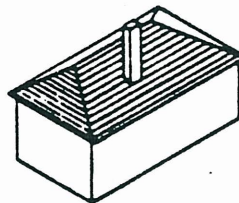

Hipped Roof

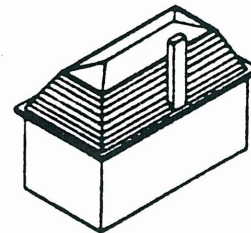

Mansard Roof

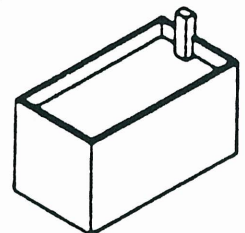

Flat Roof with Parapet

### B. Roofing Materials

#### 1. Architectural Character in Victorian Village

Slate was the most common historic roofing material. It lasts for decades and requires little maintenance. Where it remains, efforts should be made to preserve it. Today, asphalt shingles cover most Victorian Village buildings. This type of shingle has a life expectancy of 15 to 35 years. Tin or copper roofing remains on many nearly flat (e.g., porch) roofs and on inaccessible roofs. When painted periodically, metal roofs last many decades.

#### 2. Appropriate

- a. Research into and preservation of the original roofing material.
- b. Replacement of deteriorating materials with new materials that match.
- c. If the historic materials must be replaced, selection of appropriate roofing from the following materials:
  - (1) Synthetic slate shingles;
  - (2) Terra cotta tiles, especially those with a dark color and a flat, grooved texture;

(3) Asphalt or fiberglass shingles, preferably in gray tones that simulate the appearance of slate;

(4) Asphalt or fiberglass shingles in black, gray, or dark brown.

**3. Not Appropriate**

a. Light colored roofing materials.

b. Replacing original slate or tile roofing before obtaining an estimate of the cost of repairing the slate or tile.

c. Wood shakes or shingles unless historically appropriate.

d. Rolled asphalt or fiberglass roofing.

e. Corrugated roofing.

**C. Dormers**

**1. Architectural Character in Victorian Village**

Dormers are used to add light and ventilation to the upper floor of houses. They typically contain one or more windows and have fairly steep gabled roofs that channel water away from the windows. They are integral to the building's design.

**2. Appropriate**

a. Retaining the style, details, and dimensions of the historic dormers.

b. If new dormers are being considered, they should be located in such a way that the appearance of the house is changed as little as possible, and so the appearance is complimented by the addition.

**3. Not Appropriate**

a. Replacing dormer windows with a larger, horizontal window.

b. Replacing dormer windows with doors.

c. Removing dormers that were historically part of the building.

**D. Gutters and Downspouts**

**1. Architectural Character in Victorian Village**

Original gutter types found in Victorian Village include box, stop, and metal half-round gutters. These are often essential design features. Changing the gutter design could irreparably alter the building's historic appearance.

## Public Notices

### GUIDELINE AMENDMENT VICTORIAN VILLAGE COMMISSION

This amendment was discussed and passed at the December 14, 2000 Victorian Village Commission meeting and is taken from the meeting minutes verbatim.

- Following public comment, approve the following amendment to The Victorian Village Handbook regarding roof replacement. The Commission is amending the guidelines to remove the shingle colors brown and black. Due to the availability of slate colored shingles and the continued loss of historic slate roofs in the Victorian Village Historic District, the Commission determined that it is appropriate for roofs to return to and/or retain a slate colored appearance. Additionally, all ridges and hips are to be capped with galvanized metal ridge roll painted Tinner's Red.

MOTION: Brownstein/Hayes (5-0-0)  
AMENDMENT TO GUIDELINES APPROVED.

Diane Cole, AICP  
Historic Preservation Officer  
(9/29; 10/6/01)



Figure 23

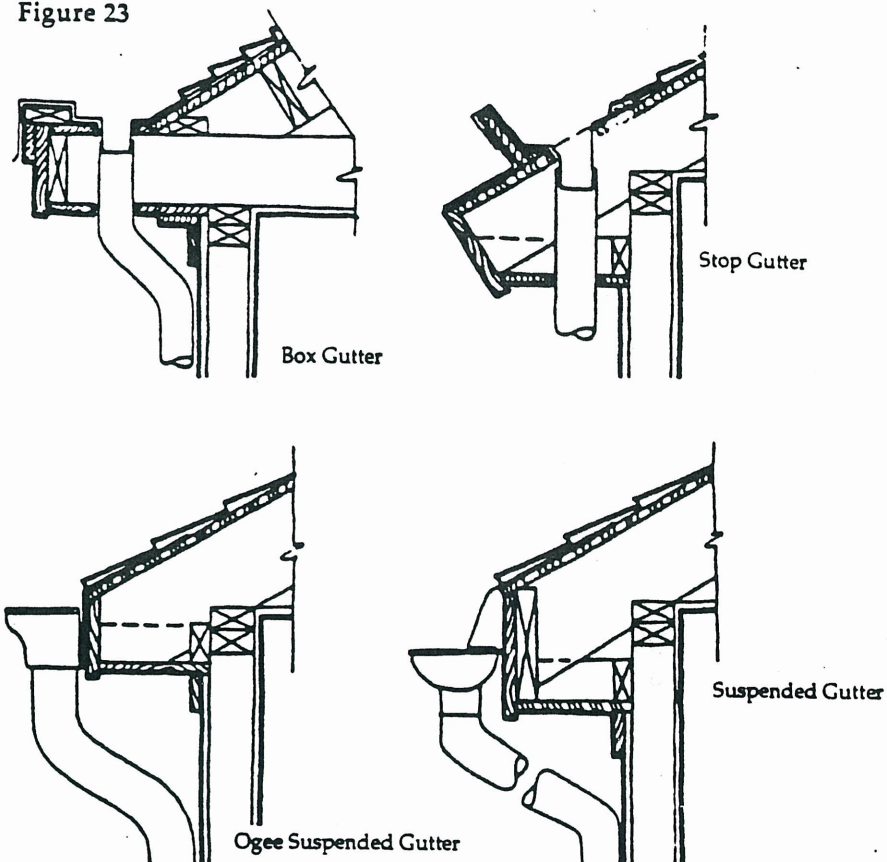

Figure 23: Types of gutters.  
Source: Italian Village Guidelines.

## 2. Technical Information

It is possible to line the inside of a box gutter using synthetic rubber material that will help to prolong the life of the gutter. Before relining box gutters, it may be necessary to replace rotted wood and damaged or corroded metal.

## 3. Appropriate

- a. Preserving box gutters.
- b. Aluminum gutters if original materials cannot be repaired or are missing.
- c. Retaining or duplicating moldings.
- d. Gutters painted to match the existing trim color.

## 4. Not Appropriate

- a. The complete removal of box gutters and moldings, which alters the roof overhang and destroys important original detailing.
- b. Covering cornice moldings and other decorative wood trim with metal plates as a quick repair instead of needed maintenance.
- c. Removing original gutters and moldings for ease of maintenance.
- d. Removing box gutters before obtaining an estimate of the cost of repairing them.

Figure 24

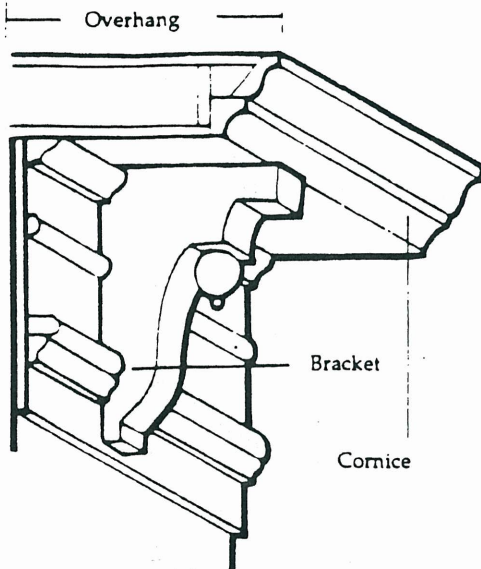

Figure 24: Source: Italian Village Guidelines.

Figure 25

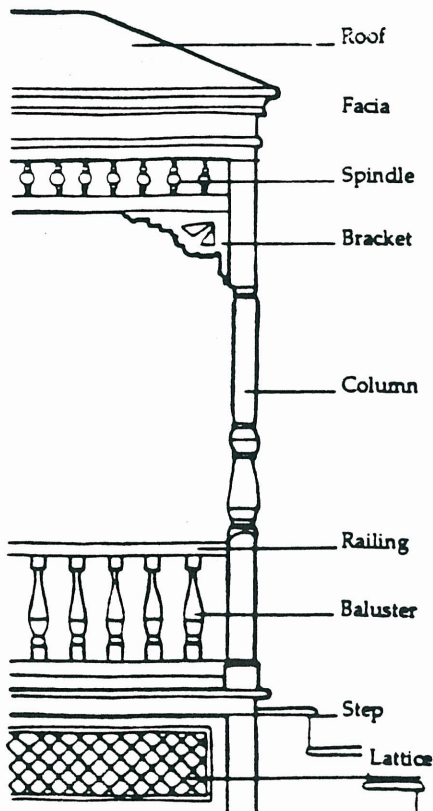

Figure 25: Typical porch elements. Source: Italian Village Guidelines.

## E. Cornices and Brackets

### 1. Architectural Character in Victorian Village

The original overhang of a Village building, with its cornice, and occasionally brackets, helps define the decorative character of the building. Removal irreparably alters the appearance of the structure and greatly lessens its historic value.

### 2. Appropriate

Retention or, if necessary, careful replacement in kind of cornices, brackets, crown moldings, and other decorative roofline features.

### 3. Not Appropriate

Removal of cornice, brackets, and decorative roof overhang features.

## F. Other Roof Features

### 1. Appropriate

- Ridge caps and roof finials preserved or replaced and painted with metal preserving paint in tinner's red, black, gray, or dark brown.
- Roof vents, if installed, painted to match the roof color.
- Skylights placed so that visibility from the street is minimized. Installation of flat skylights that are nearly flush with the surface of the roof.

### 2. Not Appropriate

- Skylights that are readily visible from the street, especially bubble-shaped skylights.
- Exterior antennas that are visible from the street, including satellite dishes.

## IX. Porches

### A. Architectural Character in Victorian Village

1. Porches are focal points of a facade and deserve proper rehabilitation. Some porches are little more than a cover for the front stoop, while other span the entire front and side of the house. Even where decorative, columns are weight-bearing in appearance.

### B. Appropriate

- Replacing wood columns or, where deteriorated, adding new sections that duplicate historic columns.
- Restoring architectural features made of wood, iron, stone, or brick.
- Constructing a new porch in an architectural style, scale, and character using material compatible with the principal structure.

### C. Not Appropriate

- Wrought iron porch columns, especially those with "grapevine" detailing.
- Treated, unpainted lumber and wood decks easily seen from the street.
- Corrugated roofing material.
- Covering porch floors and steps with carpet or false turf which can result in the decay of wood porch floors and stairs.
- Removing balusters and other decorative elements.

## X. New Construction

### A. Technical Information

The specific guidelines for residential rehabilitation, above, and those for commercial rehabilitation, below, respectively set forth the matters to be considered by builders of new structures. In addition, this section sets forth general rules of appropriateness. New structures may be contemporary but must be compatible.

### B. Appropriate

1. New buildings that conform to or are otherwise compatible with existing structures on the street, maintaining harmony.

Figure 26

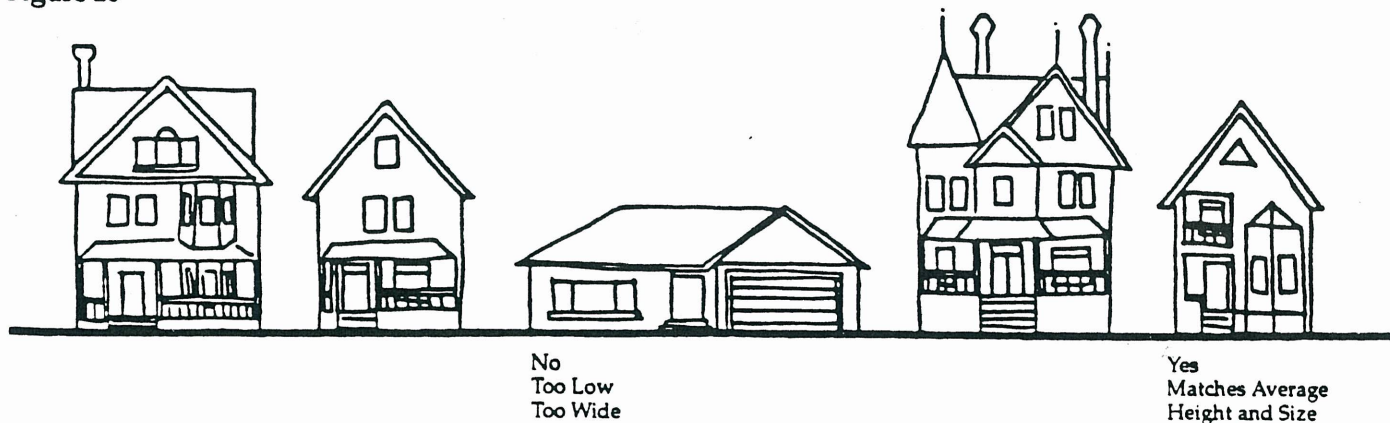

Figure 27

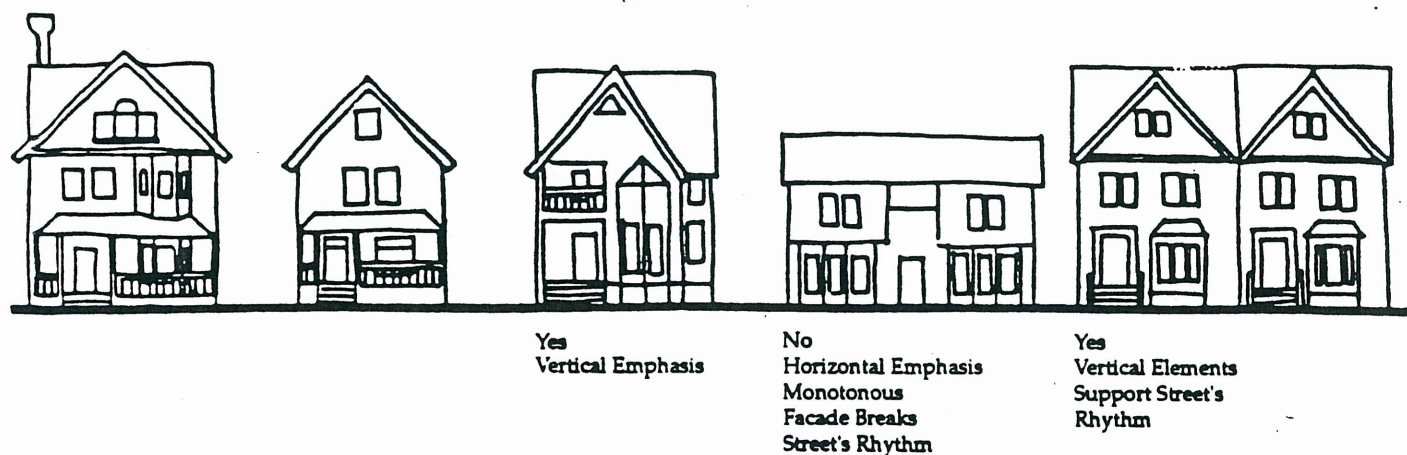

Figure 26: Proportion of building facades. Source: Gainesville, Florida Guidelines.

Figure 27: Rhythm of buildings. Source: Gainesville, Florida Guidelines.

2. Detailing similar in form, proportion, scale, texture, materials, and color to those on surrounding structures.
3. Roof pitch, height, and shingles compatible with those on existing, surrounding structures. Generally, no roof pitch less than 6 over 12 is approved unless the roof is hipped or flat.

Figure 28



Figure 28: roof shapes. Source: Gainesville, Florida Guidelines.

4. The height, width, and spacing of doors and windows compatible with similar structures nearby.
5. Spacing between new and neighboring buildings akin to that between existing buildings.
6. New buildings set back from the street the same distance as existing buildings.
7. Additions to existing buildings done in a style and level of detail similar to the existing structure and in harmony with neighboring buildings of similar use and size.
8. Accessory structures such as garages, gazebos, decks, arbors, and greenhouses, designed to complement the primary structure on the site. The detailing may be simpler, but roofs, windows, walls and colors should be compatible with the present structure if it is an appropriate Victorian Village building. Otherwise, appropriateness will be judged according to its own details and visual impact on adjacent buildings and the Village in general.

Figure 29

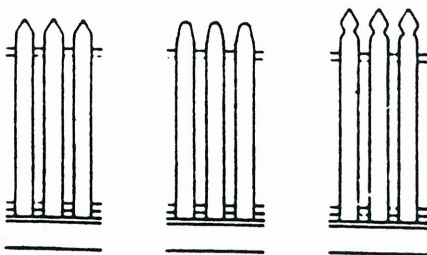

Wood Picket

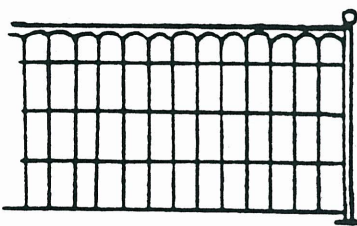

Wire Hatpin

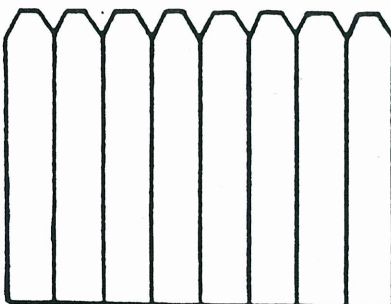

Dogeared Stockade

**C. Not Appropriate**

New buildings out of scale with existing buildings in height, width, form, relationship of solid wall spaces to doors and windows, spacing, and setback.

**XI. Fences and Yards**

**A. Architectural Character in Victorian Village**

Iron fences commonly were used for functional and decorative purposes during the 1800's. However, stone, brick, wire, and wood fences also were common in the development of Victorian Village and blend well with older homes. A fence should harmonize with the architecture of the house. It should be visually pleasing to passersby. Rustic, unpainted, wood privacy fences do not fit an urban streetscape and generally should not be visible from the street.

**B. Appropriate**

1. Fences facing the street not exceeding four feet in height.
2. Fences of iron, stone, or wood but generally not hybrids of these materials.
3. Painted (generally white picket) fences that face the street.



4. Rear fences not exceeding six feet in height.
5. Posts and braces on the inside of a board fence.
6. Board fences surrounding back yards that are not readily seen from the street.
7. Plantings that complement the house and accentuate the entrance.
8. Lighting that does not compete with street lighting.
9. Lighting that accents the decorative details of porches, doors, and walls.

Figure 30: Continuity of Fences.  
Source: Gainesville, Florida  
Guidelines.

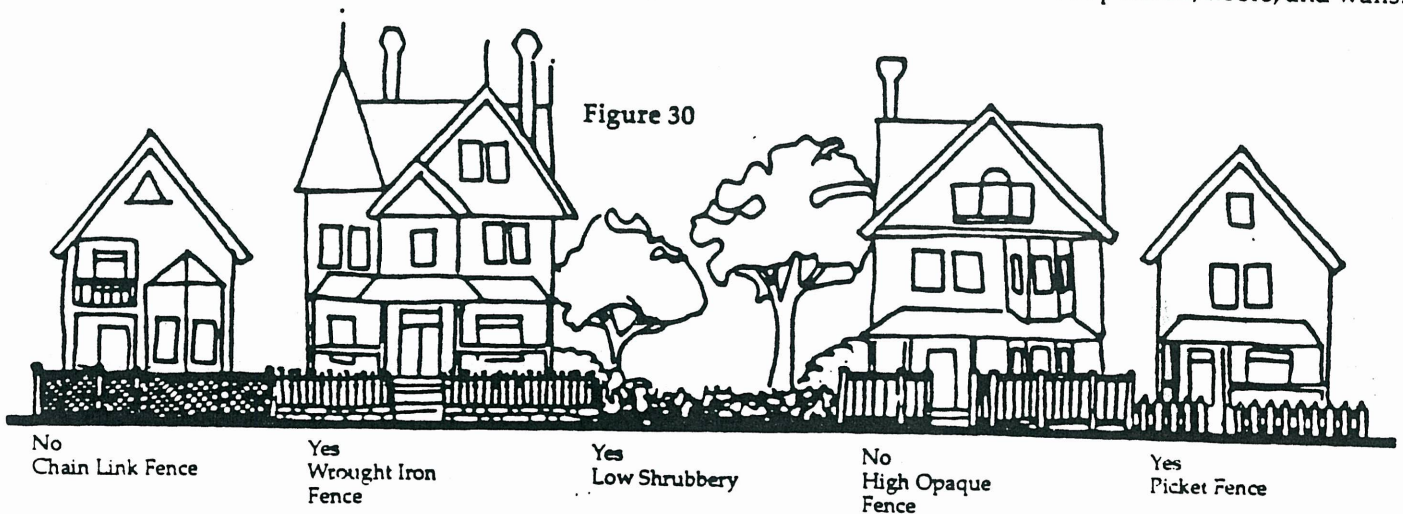

Figure 31

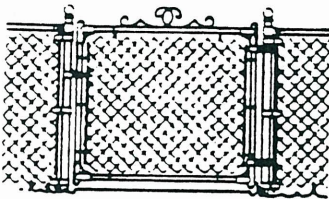

Figure 32



Figure 31: Chainlink or cyclone  
fencing - not appropriate. Source:  
Cape May Guidelines

Figure 32: Barnyard fencing, post  
and rail - not appropriate. Source:  
Cape May Guidelines.

#### C. Not Appropriate

1. Chain link fences that are visible from the street. Barnyard post and rail fences.
2. Wood fences other than picket fences facing the street, in most cases.
3. Brick pilasters in iron fences.
4. Posts and braces on the outside of a board fence.
5. Stockade fences in the rear that are not dogeared.
6. Prominent use of railroad and landscape ties and similar rustic elements that are visible from the street.
7. Plantings that when fully-grown will obstruct significant building design elements.
8. Flowering plants that drop fruits on public ways.
9. Landscape schemes that give a cluttered or busy appearance that detracts from the design of the house.
10. Air conditioning units that are readily visible from the street.

**Part IV: Guidelines For  
Commercial Rehabilitation****I. Appropriate Commercial Strip Rehabilitation**

When rehabilitating a storefront that is part of a commercial strip, one of the most important factors to consider is maintaining the street wall, the continuous line of connected facades along the street. The traditional storefronts provide the strip with its identity. Rehabilitation of the building facades should strive to maintain and reinforce this character.

**II. Storefront Rehabilitation****A. Architectural Character in Victorian Village**

Typical Victorian Village storefronts alternated recessed entrances with wide display windows. Pilasters separated these sections and transom windows were used over doors and display windows. The evaluation of the storefront's historically significant architectural features and physical condition will help to determine the best approach to actual rehabilitation work. Selecting and planning treatments that are sensitive to the architectural character of the storefront is an important key to successful rehabilitation.

**B. Appropriate**

1. A storefront that reflects the details of the individual building as well as its part in the neighboring streetscape.
2. Retaining and repairing the historic storefront.
3. If the historic storefront no longer exists, a contemporary design and materials similar in proportion, form, composition, texture, materials, and color to the rest of the building and neighboring buildings.
4. Undertaking an accurate restoration or recreation based on historical evidence.
5. If metal components have deteriorated to a point where they have failed, replacement is reasonable. In some situations, less expensive substitutes such as aluminum, wood, plastic, and fiberglass painted to match the metal can be used without compromising the distinctive architectural character.

Restoring metal architectural elements to their original condition.

6. Repairing wooden storefronts showing signs of deterioration using simple methods. Partially decayed wood should be patched, rebuilt, chemically treated, or consolidated and painted to achieve a sound condition, unified appearance, and greatly extended life.
7. Although mortar may have disintegrated, inappropriate surface coatings applied, and openings reduced or blocked, careful research of the original appearance of the building and restoration and rehabilitation should be undertaken.
8. Preserving or restoring distinctive details, such as bay windows, cornice treatments, or a parapet with the historic owner's name.

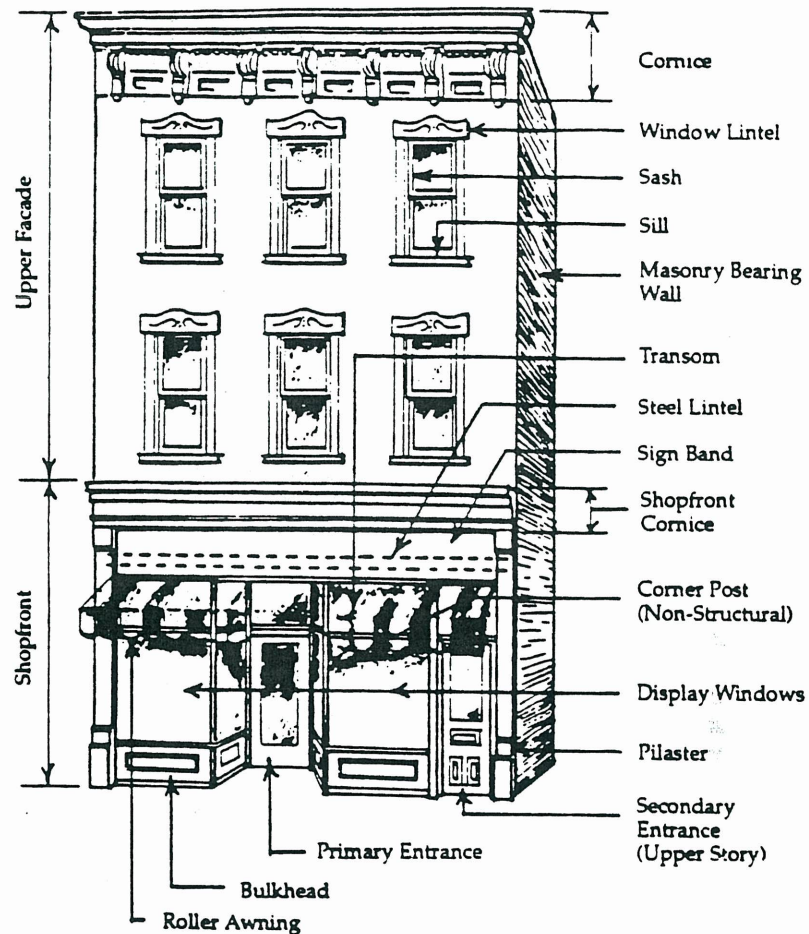

Figure 33

Figure 33: Victorian era storefront features. Source: The Old House Journal, Illustration by Jonathan Poore.

9. Choosing paint colors based on research into the building's historic appearance. Two, three, or four colors may be utilized in some cases.
  10. Compatible materials that were not available when the first storefront was constructed, including vinyl and aluminum siding, anodized aluminum, mirrored or tinted glass, artificial stone, and brick veneer. (The discussion of vinyl and aluminum siding and other modern materials in the residential section of these guidelines is relevant here.)
- C. Not Appropriate**
1. Use of some stock lumberyard detailing. This includes coach lanterns, mansard overhangs, woodshake shingles and siding, inoperable shutters, and small-pane windows except where they existed historically.
  2. Painting surfaces that never have been painted.
  3. Too many contrasting colors.

### III. Storefront Signage

#### A. Architectural Character in Victorian Village

Historically, commercial signage in the Village was pedestrian-oriented. It stated its message in simple, succinct language. Often a stone lintel between the first and second story served as a base for a sign.

## B. Appropriate

1. Preserving the historic signage.
2. A sign that is a logical component of the overall design of the building. The use of a well designed logo or symbol as an effective accent to the architectural character of the building and the street.
3. Emphasizing the character and scale of Victorian Village with special consideration for the residential neighborhood.
4. The shape, size, and placement of street graphics oriented toward pedestrians along the sidewalk rather than toward vehicles moving at higher speeds.
5. Graphics that convey their message in a simple fashion. Content of signs generally restricted to the name and function of the establishment. Posting of rates and advertising of goods and related services as window signs, but not on a building zoned for residential use.
6. Signs illuminated from the interior in institutional and commercial, but not residential, zoned areas.
7. Ground signs only if no other solution is feasible. (Wall and projecting signs generally are preferred.)
8. Temporary, standard real-estate signs may be used without Commission approval.
9. Projecting signs that are four feet wide or less and that are at least nine, but not more than fifteen, feet above the sidewalk.
10. Exterior structural elements of projecting signs that are an integral part of the design of the sign.
11. Wall signs, when above windows, that clear the top of the window framing.
12. Lighting for a wall sign that is an integral part of the design of the sign.
13. Buildings facing more than one street are subject to the same width, height, and other criteria that apply to signs facing those streets.
14. Banners are subject to review for design placement and appropriateness.
15. Graphics on awnings and canopies that contain only the name and function of the establishment.
16. One graphic per awning or canopy.
17. The top and bottom height of an awning or canopy, if used for graphics, determined in the same way as for wall and projecting signs.

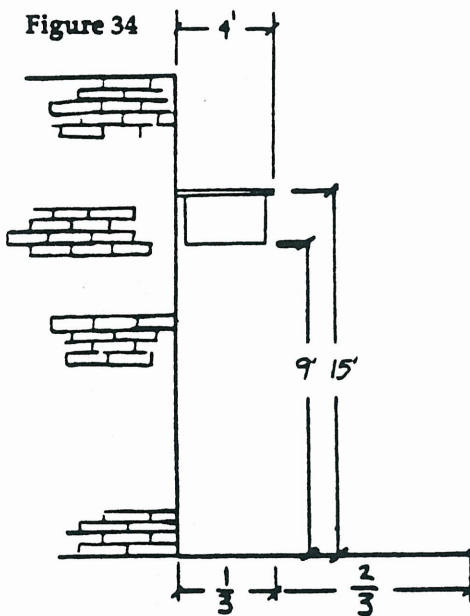

Figure 34: Projecting sign requirements.

Figure 36

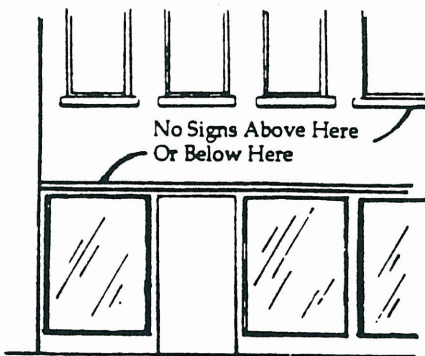

Figure 37

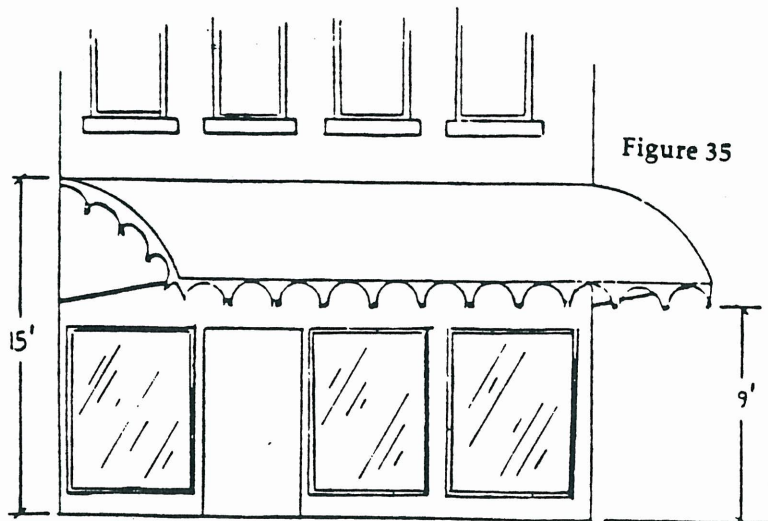
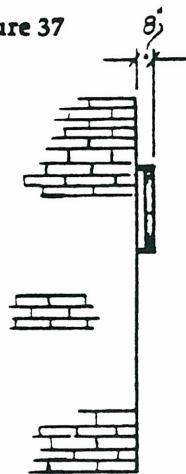

Figure 35

### C. Not Appropriate

1. Graphics that obscure or damage any significant architectural feature or detail.
2. Signs illuminated from the interior in residential-zoned areas.
3. Ground signs that exceed the height of the second story window sills of adjacent properties, the height of a roof or parapet of an adjacent one-story building, or that are over fifteen feet above an adjacent sidewalk.
4. Ground signs (signs that stand alone) that exceed 24 square feet in area.
5. Temporary or rolling signs other than standard real-estate signs.
6. The horizontal projection of a projecting sign that exceeds four feet or one-third the width of the sidewalk, whichever is less.
7. Projecting signs that exceed a height equal to that of the bottom of the second floor window sills on a multi-story building or the top of the lowest parapet wall on a single-story building. Projecting signs that are less than nine, or more than 15 feet above the sidewalk.
8. More than one projecting sign per business, with variation possible for corner businesses.
9. Wall signs mounted above the bottom of the second floor window sills of the building or nearest adjacent building. If the building is one-story, wall signs mounted above the bottom of the second floor window sills of an adjacent building.
10. Wall signs that project more than eight inches in front of the principal facade of the building.
11. Wall signs that extend horizontally beyond any continuous wall area or that cover doors, windows, or other architectural features. Wall signs that exceed two-thirds the width of the building upon which the sign is to be placed.
12. Window signs that exceed 25% of the total window area.

13. Graphic area on awnings and canopies that exceeds an area equal to the square root of the height times the width of the awning material or canopy vertical surface.
14. Off-premises signs.
15. Roof-top signs.
16. Billboards.







## APPENDIX D

## GLOSSARY

This Glossary provides short descriptions of many terms used in this Handbook. For greater comprehension, consult works listed in the bibliography (Appendix F), particularly those by Fletcher, Harris, Pitts, et al., and Poppeliers, et al.

**Baluster** - An upright, often vase-shaped, support for a rail.

**Balustrade** - A series of balusters with a rail.

**Belt Course** - A narrow horizontal band projecting from the exterior walls of a building, usually defining the interior floor levels. Also known as a bond course or a string course.

**Bevel** - an angled surface, corner, or edge, typically on window and door glass and porch columns.

**Bracket** - A support under eaves, often more decorative than functional.

**Casement** - A window with sash hung vertically and opening inward or outward.

**Chimney Pot** - A pipe placed on top of a chimney, usually of earthenware.

**Clapboard** - A long, thin board with the lower edge thicker than the upper, overlapped to cover the outer walls of frame structures, sometimes called weatherboard.

**Column** - A vertical porch support, generally consisting of a base, shaft, and capital.

**Coping** - A protective cap, top, or cover of a wall, chimney, or pilaster.

**Corbel** - A bracket or block projecting from the face of a wall that generally supports a cornice, beam, or arch.

**Cornice** - The projecting ornamental molding along the top of a building or wall.

**Cresting** - Roof ornamentation, such as cast iron fencing.

**Cupola** - A dome-shaped roof on a circular base that rises like an inverted cup atop a building.

**Dentil** - A toothlike decoration that appears on Classical cornices.

**Dormer** - A roofed structure housing a vertically set window on a sloping roof.

**Double-hung Sash Window** - A window with two sashes, one above the other, arranged to slide vertically past each other.

**Eaves** - The projecting overhang at the lower edge of a roof.

**Elevation** - A two-dimensional representation of an exterior face of a building.

**Finial** - An ornament at the top of a spire, gable, or pinnacle, typically on a roof.

**Gable** - A triangular wall segment at the end of a double-pitched (gabled) roof.

**Hipped Roof** - A roof with four uniformly pitched sides.

**Lattice** - Often diagonal strips of laths used as screening, typically on porches.

**Lintel** - The piece of stone or wood that covers a window or door opening and supports weight above it.

**Mansard Roof** - A roof that has a gentle upper slope and a steep lower slope on all four sides.

**Masonry** - Wall construction of materials such as stone or brick.

**Molding** - Decoration that is either carved into or applied to a surface.

**Ogee** - A form of molding or arch made up of a convex and concave curve.

**Palladian Window** - A three part opening with an arched central window and flanking rectangular windows.

**Parapet** - A low, solid wall or railing along the edge of a roof or balcony.

**Pediment** - A wide, low-pitched triangle crowning doors, windows, or niches.

**Pendant** - A suspended or hanging ornament used in roof gables, often tear-shaped.

**Picturesque** - the romantic Nineteenth Century taste for controlled informality in architecture and landscape gardening.

**Pilaster** - A shallow pillar attached to a wall, often constructed to match columns, especially on porches.

**Polychromy** - The use of many colors in architectural decoration.

**Quoin** - Stones, bricks, or occasionally, wood used to accentuate the corners of a building.

**Rustication** - Masonry cut in massive blocks separated by deep mortar joints.

**Sash** - A frame in which the pane(s) of a window are set.

**Spindle** - A turned, wooden, vertical support often used in stair railings and porch trim.

**String Course** - A molding or projecting band running horizontally along the face of a building, also known as a bond course or belt course.

**Transom** - The horizontal division in a window or, more commonly a short window opening above a door.

**Turret** - A small tower, usually at the corner of a building.

**Widow's Walk** - A narrow platform on a roof, often bounded by cresting.

## APPENDIX E

## BIBLIOGRAPHY

- Blumenson, John J.-G., Identifying American Architecture: Pictorial Guide to Styles and Terms, 1600-1945. 2d rev. and enl. ed. Nashville: American Association for State and Local History, 1987.
- Cadavid, Maria, et al. Victorian Village Handbook. Columbus, 1985.
- Department of Community Development, Gainesville, Florida. Preservation and Conservation Manual. 2d Printing. Gainesville, FL, 1985.
- Fletcher, Bannister. A History of Architecture. 17th ed. New York: Charles Scribner's Sons, 1967.
- Harris, Cyril, ed. Dictionary of Architecture and Construction. New York: McGraw Hill, Inc., 1975.
- McAlester, Virginia and McAlester, Lee. A Field Guide to American Houses. New York: Knopf, 1984.
- Pitts, Carolyn; Fish, Michael; McCauley, Hugh; and Vaux, Trina. The Cape May Handbook. Philadelphia: The Athenaeum, 1977.
- Poppeliers, John; Chambers, Jr., S. Allen; and Schwartz, Nancy. What Style Is It? Washington, D.C.: Preservation Press, 1983.
- Rifkind, Carole. A Field Guide to American Architecture. New York: New American Library, 1980.
- Tallman, Gary; Klose, Thomas; and Elwakil, Mohamed. Italian Village: Guidelines for Rehabilitation and New Construction. Columbus, 1988. (Unpublished manuscript.)
- Whiffen, Marcus. American Architecture Since 1780: A Guide to the Styles. Cambridge, Mass: M.I.T. Press, 1969.

